

CLASSEN®

DOOR CATALOGUE

2023







CREATE
an interior
WITH CHARACTER

CLASSEN[®]



YOUR **DOORS**

CONTENTS

SYMBOLS USED IN THE CATALOGUE	6
-------------------------------------	---

LACQUERED PANEL DOORS	8
LIRGO	10
BRENTA	12
VENIS	14
LARIX	16
LINEA	18
LINEA PREMIUM	20
LINEA PREMIUM LOFT	22
MORANO	24
GRAFEN	26
SALVANO	28
CLASSIC	30

VENEER FRAMED DOORS	32
CLIF	34
MAGNETIC	36
GRECO	38
TRAFFIC	40
HAVANA	42
LUKKA	44
TOSCA	46
FERRO	48
KOFANO	50

VENEER PANEL DOORS	52
MODUL	54 NEW!
DARK	56 NEW!
MILK	58 NEW!
VERTI	60 NEW!
GLAS	62 NEW!
SAGA	64
ASTERIA NL	66
DISCOVERY	68
TETYDA	70
NATURA HR	72
ANDROMEDA	74
DEMETER	76
ARENA	78
CENTURY	80
MALAGA	82
MODENA 4	84
NATURA	86
ANTIOPE	88
SIDE PANEL	90

TECHNICAL PANEL DOORS	92
NATURA HK CPL / HB CPL	94
NATURA HK HPL / HB HPL	96
GUARD	98
BORD	100
BORD W3	102
FIRE DOORS - EI30 / EI60	104
ACOUSTIC DOORS - EI30 / 42 DB	106
VENOM	108
VENOM ALU	110
ACOUSTIC DOORS	112

DOORS ALIGNED WITH THE WALL	114
COMPACT	116

SLIDING DOOR SYSTEMS	118
DOUBLE LEAF SLIDING DOOR SYSTEM	120
SINGLE LEAF SLIDING DOOR SYSTEM	121
AERO	122
MODI DESIGN	124 NEW!
SLIDING POCKET DOOR SYSTEM - ECLISSE	125

WOOD-BASED DOOR FRAMES	126
ADJUSTABLE / ADJUSTABLE 80	128
NON-REBATED ADJUSTABLE / ADJUSTABLE 80	129
ARCUS	130
NEW ARCUS	131
STANDARD 2-PACK FIXED	132
CMOK	133

STEEL DOOR FRAMES	134
STEEL FIXED REBATED / NON-REBATED	135
STEEL ADJUSTABLE	136
STEEL ADJUSTABLE NON-REBATED	137

DEDICATED DOOR FRAMES	138
BORD STEEL FIXED / CORNER FIXED	139
BORD MDF FIXED	140
HYBRID	141
BORD W3 STEEL FIXED	142
GUARD STEEL FIXED / ADJUSTABLE	143
FIRE WOODEN FIXED / ADJUSTABLE	144
FIRE STEEL FIXED	145
42 DB MFD FIXED REBATED	146
42 DB MFD FIXED NON-REBATED	147

THE ABC OF DOORS - INFORMATION DATABASE	148
ADDITIONAL ELEMENTS	150
DOOR DIMENSIONS	151
MOULDINGS / RAL COLOURS	152
CROWNS	153
ACCESSORIES	154
HANDLES	156
VENEER	160
VENEER / LACQUER	164
HPL UNI DECORS	166
HPL WOOD DECORS	167

SYMBOLS USED IN THE CATALOGUE

— TYPE OF DOORS

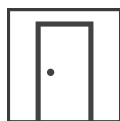

Single leaf doors

The most frequently chosen type of doors, commonly used in construction. Depending on the collection and purpose, leaves with the width from 60 to 120 cm are used. Next to this icon, you will always find the range of available widths for the selected collection.



Single leaf sliding doors

To open this door leaf, you need to slide it along a wall, it can also disappear completely into the wall cavity. There are several types of sliding systems available, so you can choose the one that suits your needs and interior design. Sliding doors are only available with a straight, non-rebated edge.



Double leaf doors

A type of door used for very wide door openings. Depending on the collection and purpose, the total width of both leaves from 120 to 200 cm is used. Active and passive leaf available only in rebated version. Next to this icon, you will always find the range of available widths for the selected collection.



Double leaf sliding doors

Two door leaves used in case of very wide door openings. There are two types of sliding systems available, so you can choose the one that suits your needs and interior design - either the on-wall or the pocket door system. Sliding doors are only available with a straight, non-rebated edge.

— TYPE OF DOOR REBATE



Hard Edge K

Widely used, aesthetically executed edge with K rebate profile is a standard finishing of a door leaf edge. An edge with K profile is stylish and always in fashion.

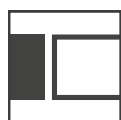

Hard Edge B

A straight edge of a non-rebated door, timeless, aesthetic and durable. This solution increases the visual value, because the door creates a uniform surface with the door frame.



Hard Edge R

Aesthetically rounded edge with the radius of 5 mm. This practical solution guarantees not only safety to our children, but also easier maintenance.



Hard Edge PF

The rounded edge of the door leaf with a radius of 4 mm, finished with flexible CPL laminates, obtained thanks to the modern technology of boards refinement - postforming. Characteristic features - abrasion resistance and safety.

— DOORS CONSTRUCTION AND FILLING

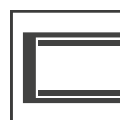

Classen Hard

Reinforced peripheral frame, consisting of two construction elements: a peripheral frame made of softwood and MDF, filled with a highly specialized cardboard. This solution guarantees increased rigidity of a door leaf and resistance against warping.

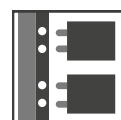

Framed construction

It consists of single elements, made entirely of wood-based material - MDF, covered with Classen decors, joined together with the use of solid mounting pins.

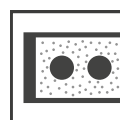

Perforated chipboard

Construction consisting of a perforated, wood-based chipboard placed between a peripheral frame made of softwood / MDF. Such construction of a door leaf guarantees high stability and increased sound absorption.

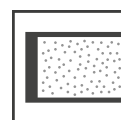

Chipboard

Construction consisting of a solid chipboard placed between a peripheral frame made of softwood / MDF. Such construction of a door leaf guarantees a high stability and very good sound absorption.



Honeycomb

It is a highly specialized cardboard with a construction and structure similar to a honeycomb, used as a standard stabilizing filling between construction / peripheral frame of a door leaf.



HLT chipboard, acoustic

A construction consisting of a solid chipboard with increased acoustic parameters, placed between a peripheral frame made of softwood and plywood.

— TECHNICAL PROPERTIES



Burglary resistance

Internal entrance doors, fulfilling the requirements of RC2 anti-burglary protection class, provide better security for your flat.



Mechanical resistance class 3

Door leaves with increased mechanical strength, especially recommended for use in buildings with high traffic, e.g. in public utility, industrial and warehouse buildings. Recommended for kindergartens, schools and hospitals.



Acoustic resistance

Doors with increased acoustic resistance. A guarantee of full comfort and freedom of action.

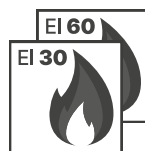

EI30 & EI60 fire doors

Fire doors designed for use in residential housing, public utility and collective residential buildings as the internal entrance doors. Thickness of a door leaf: 50 mm (for EI 30) and 60 mm (for EI 60).

— DOOR FINISHES



Primo

A basic group of wood veneers, impregnated, characterised by a required abrasion resistance.

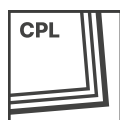

CPL

Laminate characterized by very high scratch and abrasion resistance, composed of four hot-pressed layers with the use of special adhesives, covered with a durable overlay lacquer. The main advantages include particularly high scratch and abrasion, high temperatures, UV and chemical resistance.

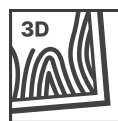

3D Look

Veneers with synchronous pores effect. The pores synchronized with the woodgrain pattern optically emboss it, which leads to creation of a three-dimensional effect. These decors perfectly imitate natural veneer.



HPL

Decorative laminate, 0.8 mm thick, based on thermosetting resins. Created of several layers, which are composed of melamine decorative papers and one or more resin-impregnated reinforcing papers. They are characterized by a very high resistance to both chemical agents and mechanical damage.



Iridium

Laminate characterized by high scratch and abrasion resistance, created in the process of hot press lamination with the use of special glues, covered with scratch resistant overlay lacquer. The main advantages include particularly high scratch and abrasion, chemical and UV resistance as well as high aesthetic value achieved due to the possibility of applying wood structure.

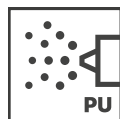

PU lacquer

Smooth satin HDF surface coated with polyurethane lacquer. Our standard offer includes collections in RAL 7004 gray and RAL 9005 black. Other colours from the RAL palette (table on page 152) are available only in this lacquer quality.

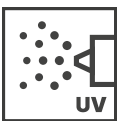

UV lacquer

HDF surface covered with primer and ecological lacquer hardened with UV rays. Standard white Lac colour is an equivalent of RAL 9003.

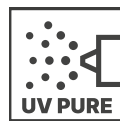

UV Pure lacquer

HDF surface coated with eco-friendly lacquer and polyurethane primer, which creates a velvety smooth surface of the door leaf. Standard white Lac colour is an equivalent of RAL 9003.



RAL palette colours

A possibility to finish the door in colours from the RAL palette as an extra-cost option, details in the table on page 152. Minimum order quantity - 3 sets (door leaf + door frame). All collections in RAL are finished in polyurethane lacquer quality.

— OTHER

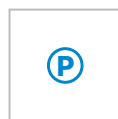

Rebated door leaf

Supplementary marking to the above icons, indicating the type of rebate that is available with a given type of door.



Non-rebated door leaf

Supplementary marking to the above icons, indicating the type of rebate that is available with a given type of door.



LACQUERED PANEL DOORS

LACQUERED PANEL DOORS

A perfect combination of modern design and high-quality workmanship. In our collections, they most often appear in the colour of timeless white, which makes them a great means to enlarge the interior optically. The minimalism of decorations gives them an elegant character. The surface of the leaves finished with lacquer is perfectly smooth. The doors are easy to clean and maintain. They are also distinguished by high durability and resistance to damage, which makes them a good investment for years.



DO YOU PREFER SIMPLICITY AND MONOCHROMATIC COLOURS? You will find them in lacquered doors with a minimalist design. Thanks to them, you will emphasize the elegant and subdued character of your apartment.

DO YOU LOVE VIVID COLOURS? Do you feel that they express your personality? Don't give up on them! Lacquered doors will harmonize beautifully with even the craziest palette of colours, while introducing balance in the interior design.



LIRGO

LACQUERED PANEL DOORS REBATED / NON-REBATED



DOOR SPECIFICATION

- peripheral frame made of MDF board, stabilizing "honeycomb" core

Rebated door leaf:

- two silver screw-in pintle hinges
- lock: mortice key lock / bathroom lock / cylinder lock / passage lock

Non-rebated door leaf:

- two openings for 3D hidden hinges
- magnetic lock: mortice key lock / bathroom lock / cylinder lock / passage lock

DEDICATED DOOR FRAMES

Hard edge K:

- standard fixed and adjustable door frame, UV white lacquered and PU black, grey lacquered

Hard edge B:

- non-rebated adjustable door frame, UV white lacquered and PU black, grey lacquered

EXTRA-COST OPTIONS

Ventilation:

- ventilation undercut
- ventilation undercut 15 mm (recuperation)

Construction:

- third hinge
- non-rebated door leaf
- sliding and passive door leaf

¹ | Minimum order quantity in the case of gray and black models – 2 sets (door leaf + door frame).



full – white



full – gray



full – black

MODELS

DETAILS



groove profile – white



groove profile – gray

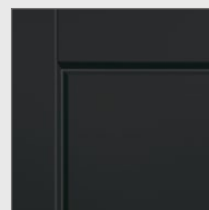

groove profile – black

UV lacquer



WHITE

PU lacquer¹



GRAY 7004



BLACK 9005

BRENTA

LACQUERED PANEL DOORS REBATED / NON-REBATED

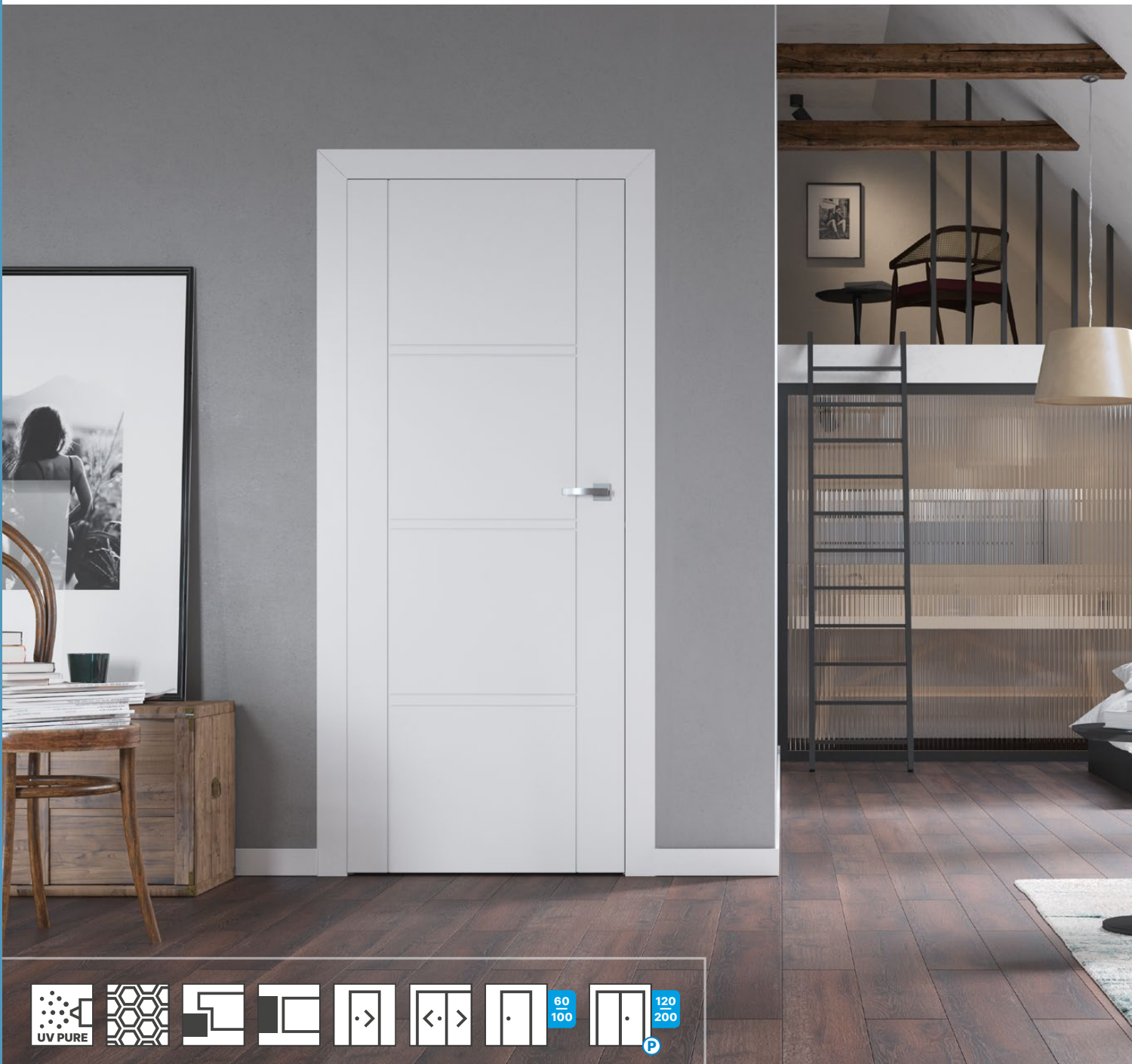

60
100



120
200

DOOR SPECIFICATION

- peripheral frame made of MDF board, stabilizing "honeycomb" core

Rebated door leaf:

- two silver screw-in pintle hinges ¹
- lock: mortice key lock / bathroom lock / cylinder lock / passage lock

Non-rebated door leaf:

- two openings for 3D hidden hinges
- magnetic lock: mortice key lock / bathroom lock / cylinder lock / passage lock

DEDICATED DOOR FRAMES

Hard edge K:

- standard fixed and adjustable door frame, UV lacquered

Hard edge B:

- non-rebated adjustable door frame, UV lacquered

EXTRA-COST OPTIONS

Ventilation:

- ventilation undercut
- ventilation undercut 15 mm (recuperation)
- ventilation sleeves (white)

Construction:

- third hinge
- perforated chipboard (rebated and non-rebated)
- non-rebated door leaf
- door leaf 100'
- sliding and passive door leaf

¹ | Door leaves 100' and reinforced door leaves regardless of the size - the set includes 3 hinges.

² | Minimum order quantity in the case of RAL colour finish - 3 sets (door leaf + door frame).

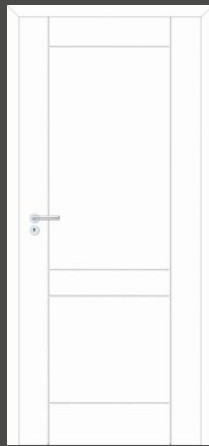

model 1



model 2

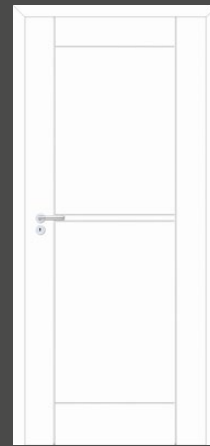

model 3

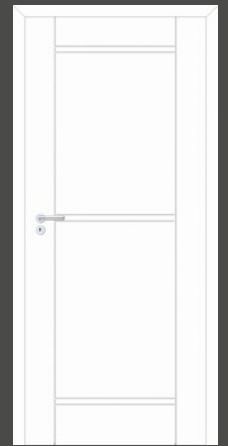

model 4

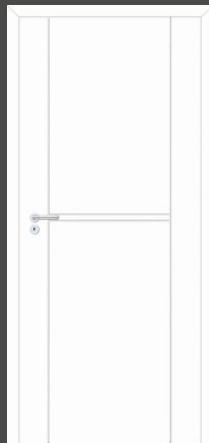

model 5



model 6

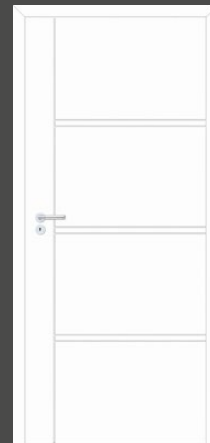

model 7

MODELS

DETAILS



groove profile

UV Pure lacquer



WHITE



AVAILABLE IN RAL
PALETTE ²

VENIS



DOOR SPECIFICATION

- peripheral frame made of MDF board, stabilizing "honeycomb" core
- milky-white toughened safety glass with an overprint

Rebated door leaf:

- two silver screw-in pintle hinges ¹
- lock: mortice key lock / bathroom lock / cylinder lock / passage lock

Non-rebated door leaf:

- two openings for 3D hidden hinges
- magnetic lock: mortice key lock / bathroom lock / cylinder lock / passage lock

DEDICATED DOOR FRAMES

Hard edge K:

- standard fixed and adjustable door frame, UV lacquered

Hard edge B:

- non-rebated adjustable door frame, UV lacquered

EXTRA-COST OPTIONS

Ventilation:

- ventilation undercut
- ventilation undercut 15 mm (recuperation)
- ventilation sleeves (white)

Construction:

- third hinge
- perforated chipboard (rebated and non-rebated)
- non-rebated door leaf
- door leaf 100'
- sliding and passive door leaf

¹ | Door leaves 100' and reinforced door leaves regardless of the size - the set includes 3 hinges.

² | Minimum order quantity in the case of RAL colour finish - 3 sets (door leaf + door frame).



model 2



model 1



model 3



model 4

MODELS

DETAILS



groove profile



glazing frame

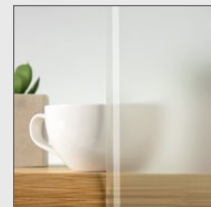

milky-white toughened safety glass with an overprint

UV Pure lacquer



WHITE



AVAILABLE IN RAL PALETTE ²



DOOR SPECIFICATION

- peripheral frame made of MDF board, perforated chipboard core

Rebated door leaf:

- three silver screw-in pintle hinges
- lock: mortice key lock / bathroom lock / cylinder lock / passage lock

Non-rebated door leaf:

- two openings for 3D hidden hinges
- magnetic lock: mortice key lock / bathroom lock / cylinder lock / passage lock

DEDICATED DOOR FRAMES

Hard edge K:

- standard fixed and adjustable door frame, UV lacquered

Hard edge B:

- non-rebated adjustable door frame, UV lacquered

EXTRA-COST OPTIONS

Ventilation:

- ventilation undercut
- ventilation undercut 15 mm (recuperation)
- ventilation sleeves (white)

Construction:

- non-rebated door leaf
- door leaf 100'
- sliding and passive door leaf

¹ | Minimum der quantity in the case of RAL colour finish – 3 sets (door leaf + door frame).



model 1

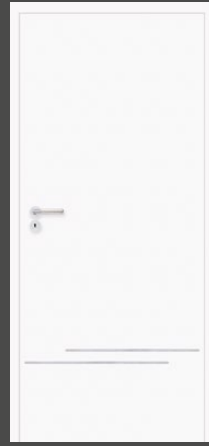

model 2

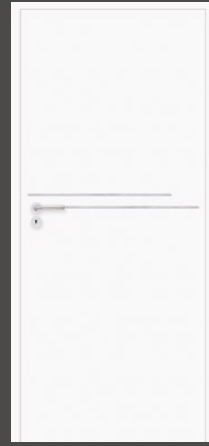

model 3

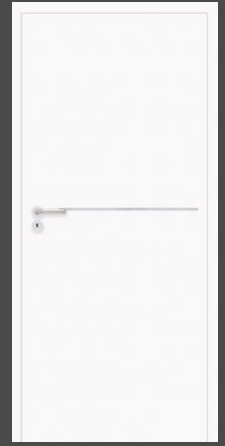

model 4

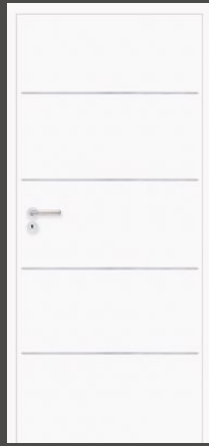

model 5

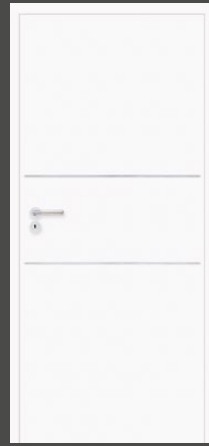

model 6

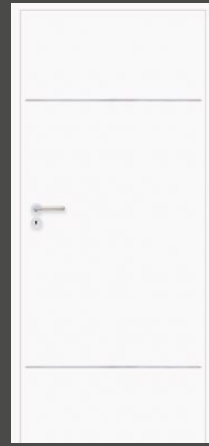

model 7

MODELS

DETAILS



aluminum profile

UV Pure lacquer



WHITE



AVAILABLE IN RAL
PALETTE ¹

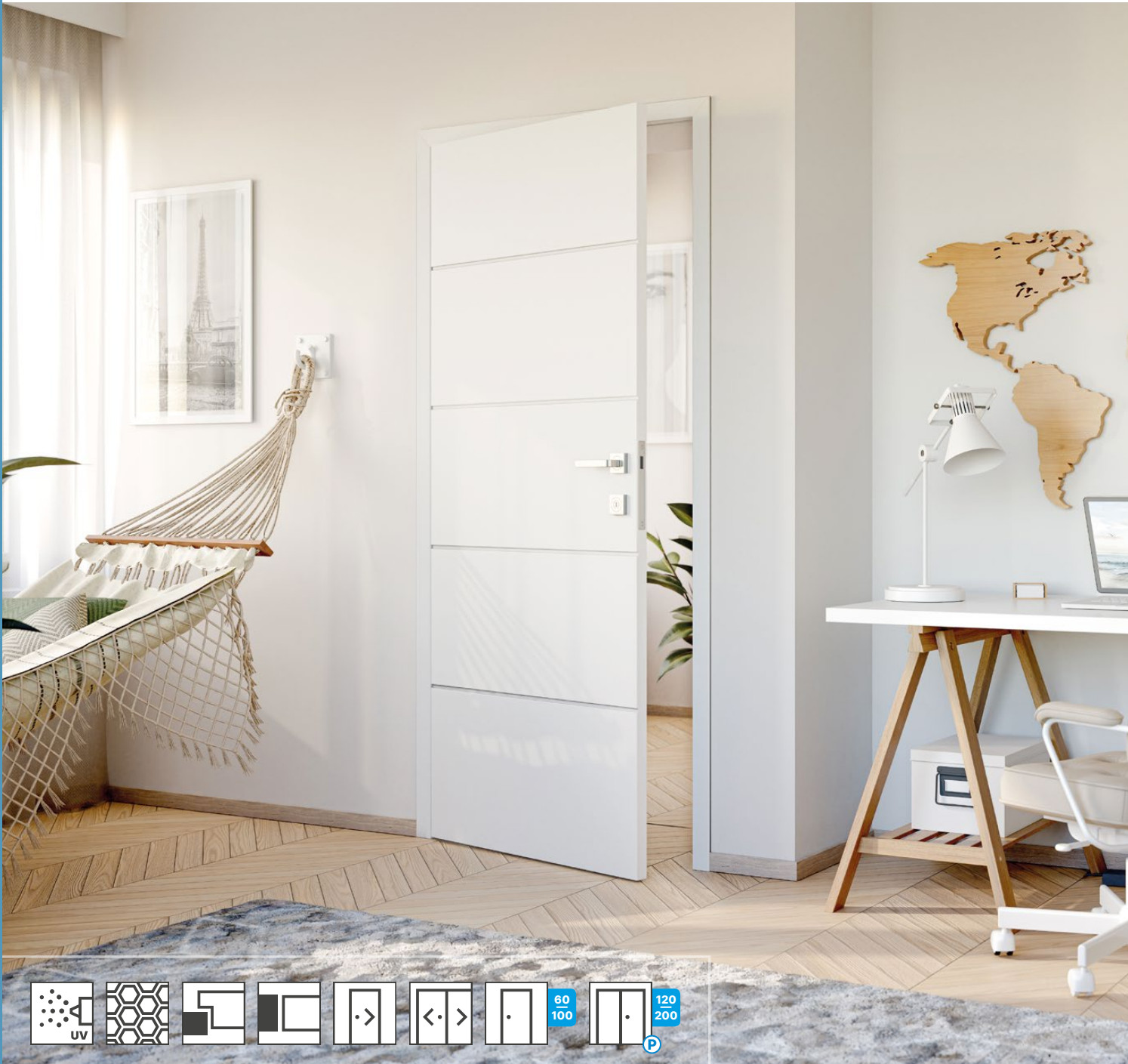

DOOR SPECIFICATION

- peripheral frame made of MDF board, stabilizing "honeycomb" core
- satin glass ¹
- glazing frame veneer with Primo – white decor

Rebated door leaf:

- two silver screw-in pintle hinges ²
- lock: mortice key lock / bathroom lock / cylinder lock / passage lock

Non-rebated door leaf:

- two openings for 3D hidden hinges
- magnetic lock: mortice key lock / bathroom lock / cylinder lock / passage lock

DEDICATED DOOR FRAMES

Hard edge K:

- standard fixed and adjustable door frame, UV lacquered

Hard edge B:

- non-rebated adjustable door frame, UV lacquered

EXTRA-COST OPTIONS

Ventilation:

- ventilation undercut
- ventilation undercut 15 mm (recuperation)
- ventilation sleeves (white)

Construction:

- third hinge
- perforated chipboard (rebated and non-rebated)
- non-rebated door leaf
- door leaf 100'
- sliding and passive door leaf

¹ | Except for model 1.2 – milky-white toughened glass with horizontal, transparent stripes.

² | Door leaves 100' and reinforced door leaves regardless of the size – the set includes 3 hinges.

³ | Minimum order quantity in the case of RAL colour finish – 3 sets (door leaf + door frame).

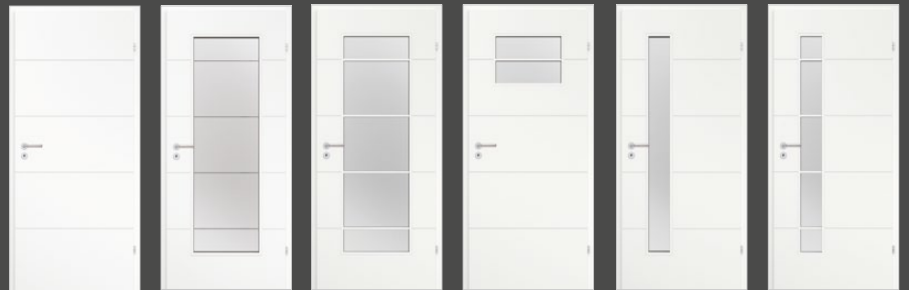

model 1.1 model 1.2 model 1.3 (with muntin) model 1.4 (with muntin) model 1.5 model 1.6 (with muntin)



model 1.7 (with muntin) model 2.1 (smooth) model 2.2 model 2.3 model 2.4



model 2.5 model 2.6 model 2.11 model 2.12 model 2.13 (WC overprint)

MODELS

DETAILS



glazing frame

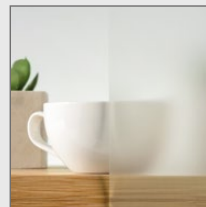

satin glass

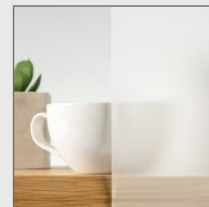

milky-white toughened safety glass for models 1.2 and 1.3



groove profile

UV lacquer



WHITE



AVAILABLE IN RAL PALETTE ³

LINEA PREMIUM

LACQUERED PANEL DOORS REBATED / NON-REBATED



DOOR SPECIFICATION

- peripheral frame made of MDF board, stabilizing "honeycomb" core

Rebated door leaf:

- two silver screw-in pintle hinges ¹
- lock: mortice key lock / bathroom lock / cylinder lock / passage lock

Non-rebated door leaf:

- two openings for 3D hidden hinges
- magnetic lock: mortice key lock / bathroom lock / cylinder lock / passage lock

DEDICATED DOOR FRAMES

Hard edge K:

- standard fixed and adjustable door frame, UV lacquered

Hard edge B:

- non-rebated adjustable door frame, UV lacquered

EXTRA-COST OPTIONS

Ventilation:

- ventilation undercut
- ventilation undercut 15 mm (recuperation)
- ventilation sleeves (white)

Construction:

- third hinge
- perforated chipboard (rebated and non-rebated)
- non-rebated door leaf
- door leaf 100'
- sliding and passive door leaf

¹ | Door leaves 100' and reinforced door leaves regardless of the size – the set includes 3 hinges.

² | Minimum order quantity in the case of RAL colour finish – 3 sets (door leaf + door frame).



model 1



model 2



model 3



model 4



model 5



model 10 (smooth)

MODELS

DETAILS

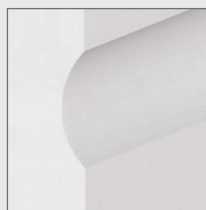

groove profile

UV Pure lacquer



WHITE



AVAILABLE IN RAL
PALETTE ²

LINEA PREMIUM LOFT

LACQUERED PANEL DOORS REBATED / NON-REBATED



DOOR SPECIFICATION

- peripheral frame made of MDF board, stabilizing "honeycomb" core

Rebated door leaf:

- two silver screw-in pintle hinges ¹
- lock: mortice key lock / bathroom lock / cylinder lock / passage lock

Non-rebated door leaf:

- two openings for 3D hidden hinges
- magnetic lock: mortice key lock / bathroom lock / cylinder lock / passage lock

DEDICATED DOOR FRAMES

Hard edge K:

- standard fixed and adjustable door frame, PU lacquered

Hard edge B:

- non-rebated adjustable door frame, PU lacquered

ADDITIONAL INFORMATION

- min. order quantity – 2 sets

EXTRA-COST OPTIONS

Ventilation:

- ventilation undercut
- ventilation undercut 15 mm (recuperation)
- ventilation sleeves (graphite)

Construction:

- third hinge
- perforated chipboard (rebated and non-rebated)
- non-rebated door leaf
- door leaf 100'
- sliding and passive door leaf

Finish:

- door frames: extra-cost of PU lacquer, acc. to RAL table, group III (page 152)

¹ | Door leaves 100' and reinforced door leaves regardless of the size – the set includes 3 hinges.



model 1

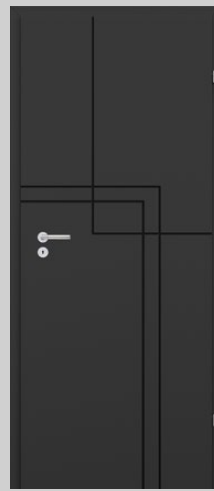

model 2



model 3



model 4



model 5

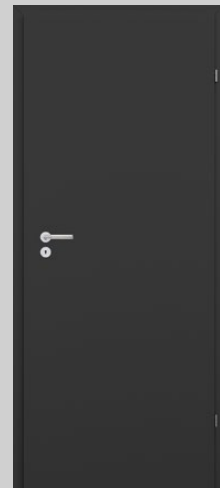

model 10 (smooth)

MODELS

DETAILS



groove profile

PU lacquer



9005 BLACK MATT

MORANO



DOOR SPECIFICATION

- peripheral frame made of MDF board, stabilizing "honeycomb" core
- satin glass
- glazing frame veneer with Primo – white decor, except for models 2.7-2.10 (lacquered frame)

Rebated door leaf:

- two silver screw-in pintle hinges
- lock: mortice key lock / bathroom lock / cylinder lock / passage lock

Non-rebated door leaf:

- two openings for 3D hidden hinges
- magnetic lock: mortice key lock / bathroom lock / cylinder lock / passage lock

DEDICATED DOOR FRAMES

Hard edge K:

- standard fixed and adjustable door frame, UV lacquered

Hard edge B:

- non-rebated adjustable door frame, UV lacquered

EXTRA-COST OPTIONS

Ventilation:

- ventilation undercut
- ventilation undercut 15 mm (recuperation)
- ventilation sleeves (white)

Construction:

- third hinge
- non-rebated door leaf
- sliding and passive door leaf

Glazing:

- transparent glass for the following models: 1.4, 1.5, 2.3, 2.4, 2.5 (NEW)

¹ | Minimum der quantity in the case of RAL colour finish – 3 sets (door leaf + door frame).



model 1.1



model 1.2



model 1.3



model 1.4



model 1.5
(with muntin)



model 2.1



model 2.2



model 2.3



model 2.4
(with muntin)



model 2.5
(with muntin)



model 2.6



model 2.7



model 2.8



model 2.9



model 2.10
(with muntin)

MODELS

DETAILS



glazing frame

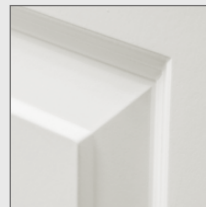

groove profile

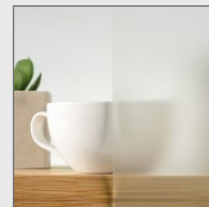

satin glass

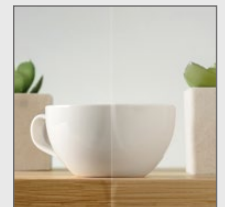

transparent glass, optional
for the following models:
1.4, 1.5, 2.3, 2.4, 2.5

UV lacquer



WHITE



AVAILABLE IN RAL
PALETTE ¹

GRAFEN

LACQUERED PANEL DOORS REBATED / NON-REBATED



DOOR SPECIFICATION

- peripheral frame made of MDF board, stabilizing "honeycomb" core

Rebated door leaf:

- two silver screw-in pintle hinges ¹
- lock: mortice key lock / bathroom lock / cylinder lock / passage lock

Non-rebated door leaf:

- two openings for 3D hidden hinges
- magnetic lock: mortice key lock / bathroom lock / cylinder lock / passage lock

DEDICATED DOOR FRAMES

Hard edge K:

- standard fixed and adjustable door frame, UV lacquered

Hard edge B:

- non-rebated adjustable door frame, UV lacquered

EXTRA-COST OPTIONS

Ventilation:

- ventilation undercut
- ventilation undercut 15 mm (recuperation)
- ventilation sleeves (white)

Construction:

- third hinge
- perforated chipboard (rebated and non-rebated)
- non-rebated door leaf
- door leaf 100'
- sliding and passive door leaf

¹ | Door leaves 100' and reinforced door leaves regardless of the size – the set includes 3 hinges.

² | Minimum der quantity in the case of RAL colour finish – 3 sets (door leaf + door frame).



model 1



model 2

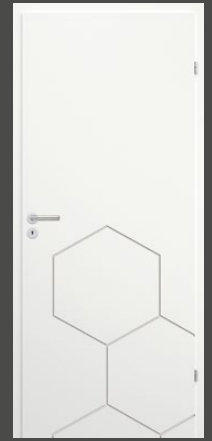

model 3



model 4

MODELS

DETAILS

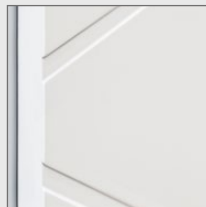

groove profile

UV Pure lacquer



WHITE



AVAILABLE IN RAL
PALETTE ²

SALVANO

LACQUERED PANEL DOORS REBATED / NON-REBATED



DOOR SPECIFICATION

- peripheral frame made of softwood, perforated chipboard core
- milky-white toughened safety glass

Rebated door leaf:

- three silver screw-in pintle hinges
- lock: mortice key lock / bathroom lock / cylinder lock / passage lock

Non-rebated door leaf:

- two openings for 3D hidden hinges
- magnetic lock: mortice key lock / bathroom lock / cylinder lock / passage lock

DEDICATED DOOR FRAMES

Hard edge K:

- standard fixed and adjustable door frame, UV lacquered

Hard edge B:

- non-rebated adjustable door frame, UV lacquered

EXTRA-COST OPTIONS

Ventilation:

- ventilation undercut

Construction:

- non-rebated door leaf
- door leaf 100'

¹ | Minimum der quantity in the case of RAL colour finish – 3 sets (door leaf + door frame).



model 1



model 2



model 3



model 4



model 5

MODELS

DETAILS

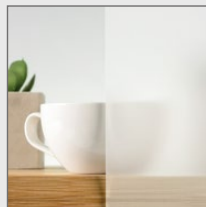

milky-white toughened safety glass

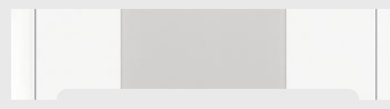

ventilation undercut for all models

UV Pure lacquer



WHITE



AVAILABLE IN RAL PALETTE ¹

CLASSIC

LACQUERED PANEL DOORS REBATED



DOOR SPECIFICATION

- peripheral frame made of MDF board, stabilizing honeycomb core
- ornamental glass, transparent bark

Rebated door leaf:

- two silver screw-in pintle hinges
- lock: mortice key lock / bathroom lock / cylinder lock / passage lock

DEDICATED DOOR FRAMES

Hard edge K:

- standard fixed and adjustable door frame, UV lacquered

EXTRA-COST OPTIONS

Ventilation:

- ventilation sleeves, white
- ventilation undercut
- ventilation grille

Construction:

- third hinge
- passive door leaf



full



1/3 glass



2/3 glass



3/3 glass

MODELS

DETAILS



ornamental glass,
transparent bark



glazing frame



door structure

UV lacquer



STRUCTURE EFFECT
WHITE



VENEER FRAMED DOORS



veneer framed doors

Classics at its best. A great proposition for those who choose timeless elegance instead of succumbing to seasonal fashions. The framed construction provides the leaves with stability and increased resistance to damage. Inside the strong frame there are various types of fillings, including coffers, glazing, HDF panels and even mirrors. The variety of available models not only provides a real feast for the eye, but also a comfort of choosing for future users. Choosing the door that best suits individual preferences and is precisely tailored to the needs of the buyers.



DO YOU WANT TO WARM UP THE DECOR? Wood will be great for this. Not only on the floor, but also on the door leaves. Wood-like veneers with a three-dimensional structure will enhance the feeling of coziness.

INTERIOR CLOSE TO NATURE. Live plants, woven baskets and ecological decorations create a wonderful atmosphere. It will be complemented by wood structure framed door, which you can easily adapt to the colour scheme of your apartment.



CLIF

VENEER FRAMED DOORS REBATED



DOOR SPECIFICATION

- frame elements made of MDF board
- satin glass or HDF panel in the door leaf colour, thickness 4 mm

Rebated door leaf:

- three silver screw-in hinges
- lock: mortice key lock / bathroom lock / cylinder lock / passage lock

DEDICATED DOOR FRAMES

Hard edge K:

- fixed and adjustable door frames for rebated doors

EXTRA-COST OPTIONS

Ventilation:

- ventilation undercut
- ventilation undercut 15 mm (recuperation)

Construction:

- door leaf 100'
- sliding and passive door leaf



model 1



model 2



model 3



model 4



model 5



model 6

MODELS

DETAILS



satin glass

3D LOOK

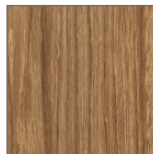

HONEY CATANIA

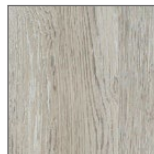

GESSATO OAK

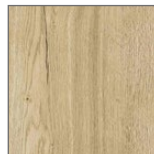

CLEVELAND OAK



COLOMBIA LIGHT WALNUT

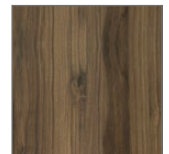

CATANIA OAK

IRIDIUM

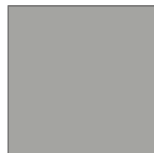

GRAY MATT



MARONE OAK

CPL



NORWEGIAN ASH

MAGNETIC

VENEER FRAMED DOORS REBATED



DOOR SPECIFICATION

- frame elements made of MDF board
- satin glass or HDF panel in the door leaf colour, thickness 4 mm

Rebated door leaf:

- three silver screw-in hinges
- lock: mortice key lock / bathroom lock / cylinder lock / passage lock

DEDICATED DOOR FRAMES

Hard edge K:

- fixed and adjustable door frames for rebated doors

EXTRA-COST OPTIONS

Ventilation:

- ventilation undercut
- ventilation undercut 15 mm (recuperation)

Construction:

- door leaf 100'
- sliding and passive door leaf

¹ | Decor is available while stocks last.



model 1

model 2

model 3

model 4



model 5

model 6

model 7

model 8

MODELS

DETAILS



satin glass

3D LOOK

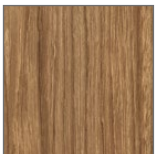

HONEY CATANIA

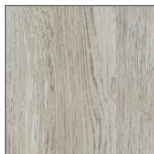

GESSATO OAK

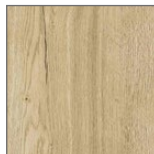

CLEVELAND OAK

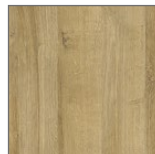

RIVIERA OAK



WHITE ASH

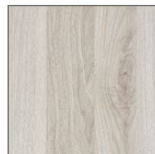

COLOMBIA LIGHT WALNUT

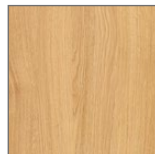

OILED OAK



BURNT OAK

3D LOOK



GRAY OAK



ANTHRACITE OAK

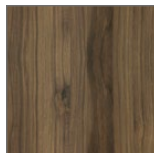

CATANIA OAK

IRIDIUM

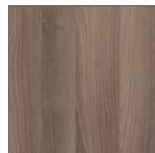

GRAPHITE ASH



WHITE MATT



MARONE OAK



GRAY MATT

CPL



NORWEGIAN ASH

GRECO

VENEER FRAMED DOORS REBATED

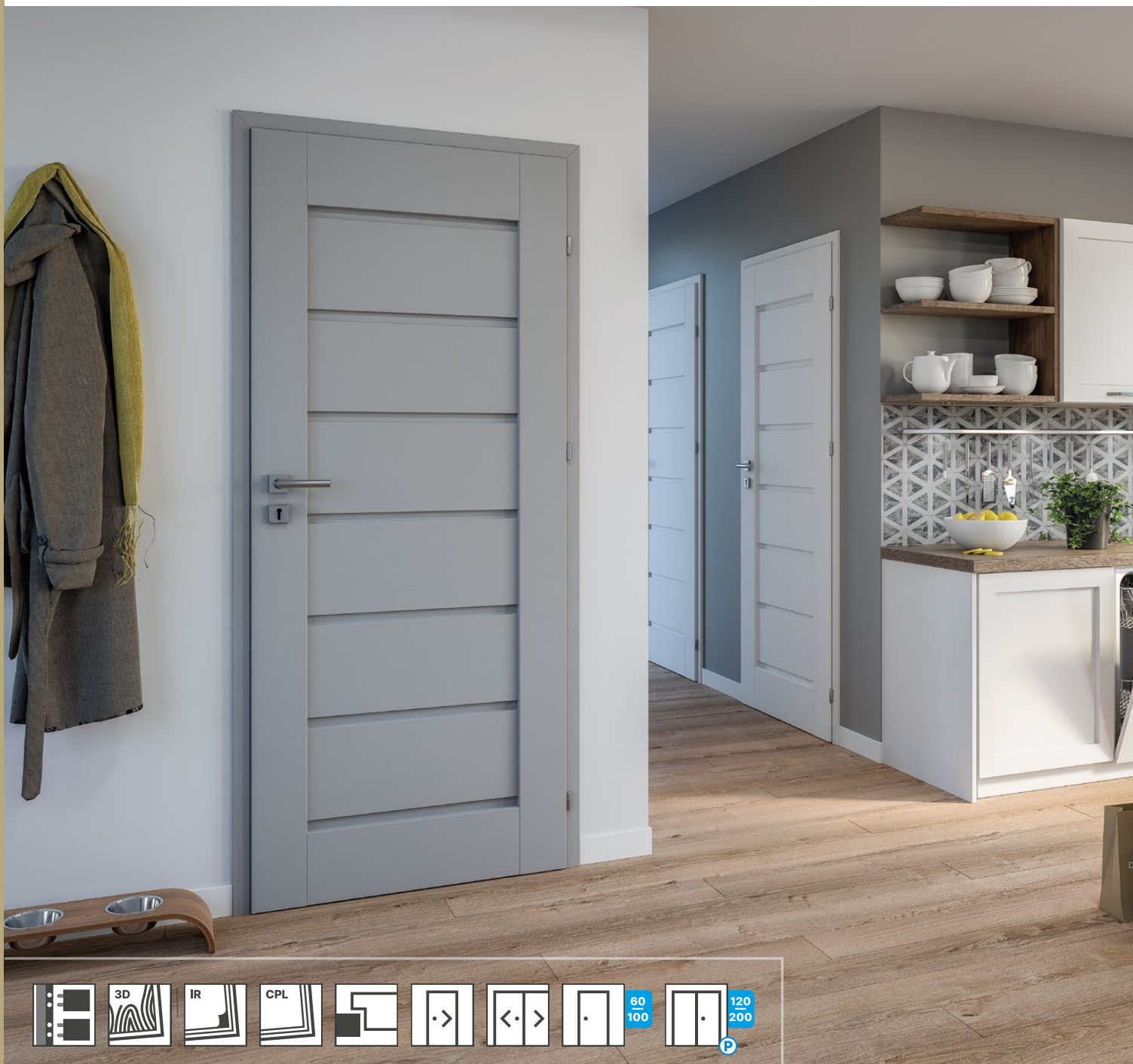

DOOR SPECIFICATION

- frame elements made of MDF board
- satin glass or HDF panel in the door leaf colour, thickness 4 mm

Rebated door leaf:

- three silver screw-in hinges
- lock: mortice key lock / bathroom lock / cylinder lock / passage lock

DEDICATED DOOR FRAMES

Hard edge K:

- fixed and adjustable door frames for rebated doors

EXTRA-COST OPTIONS

Ventilation:

- ventilation undercut
- ventilation undercut 15 mm (recuperation)

Construction:

- door leaf 100'
- sliding and passive door leaf

¹ | Decor is available while stocks last.



model 1



model 2



model 3



model 4



model 5



model 6



model 7



model 8



model 9

MODELS

DETAILS

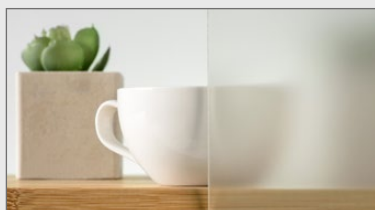

satin glass

3D LOOK

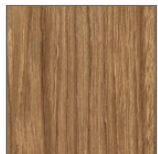

HONEY CATANIA

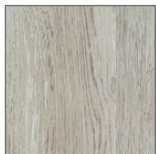

GESSATO OAK

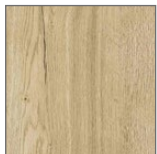

CLEVELAND OAK

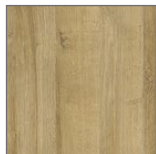

RIVIERA OAK



WHITE ASH

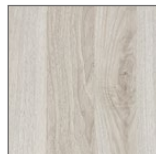

COLOMBIA LIGHT WALNUT

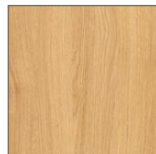

OILED OAK

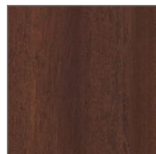

BURNT OAK

3D LOOK



GRAY OAK



ANTHRACITE OAK

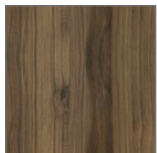

CATANIA OAK

IRIDIUM

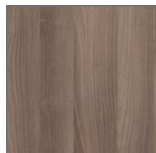

GRAPHITE ASH



WHITE MATT



MARONE OAK



GRAY MATT

CPL



NORWEGIAN ASH

TRAFFIC

VENEER FRAMED DOORS REBATED



DOOR SPECIFICATION

- frame elements made of MDF board
- satin glass or HDF panel in the door leaf colour, thickness 4 mm

Rebated door leaf:

- three silver screw-in hinges
- lock: mortice key lock / bathroom lock / cylinder lock / passage lock

DEDICATED DOOR FRAMES

Hard edge K:

- fixed and adjustable door frames for rebated doors

EXTRA-COST OPTIONS

Ventilation:

- ventilation undercut
- ventilation undercut 15 mm (recuperation)

Construction:

- door leaf 100'
- sliding and passive door leaf

¹ | Decor is available while stocks last.



model 1



model 2



model 3



model 4



model 5



model 6



model 7



model 8

MODELS

DETAILS



satin glass

3D LOOK



RIVIERA OAK



WHITE ASH



COLOMBIA LIGHT WALNUT



OILED OAK

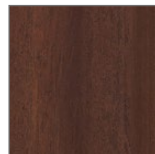

BURNT OAK¹



GRAY OAK

3D LOOK

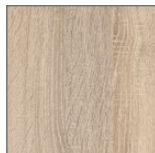

SONOMA OAK



ANTHRACITE OAK

IRIDIUM

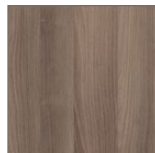

GRAPHITE ASH



WHITE MATT

CPL



NORWEGIAN ASH

HAVANA

VENEER FRAMED DOORS REBATED

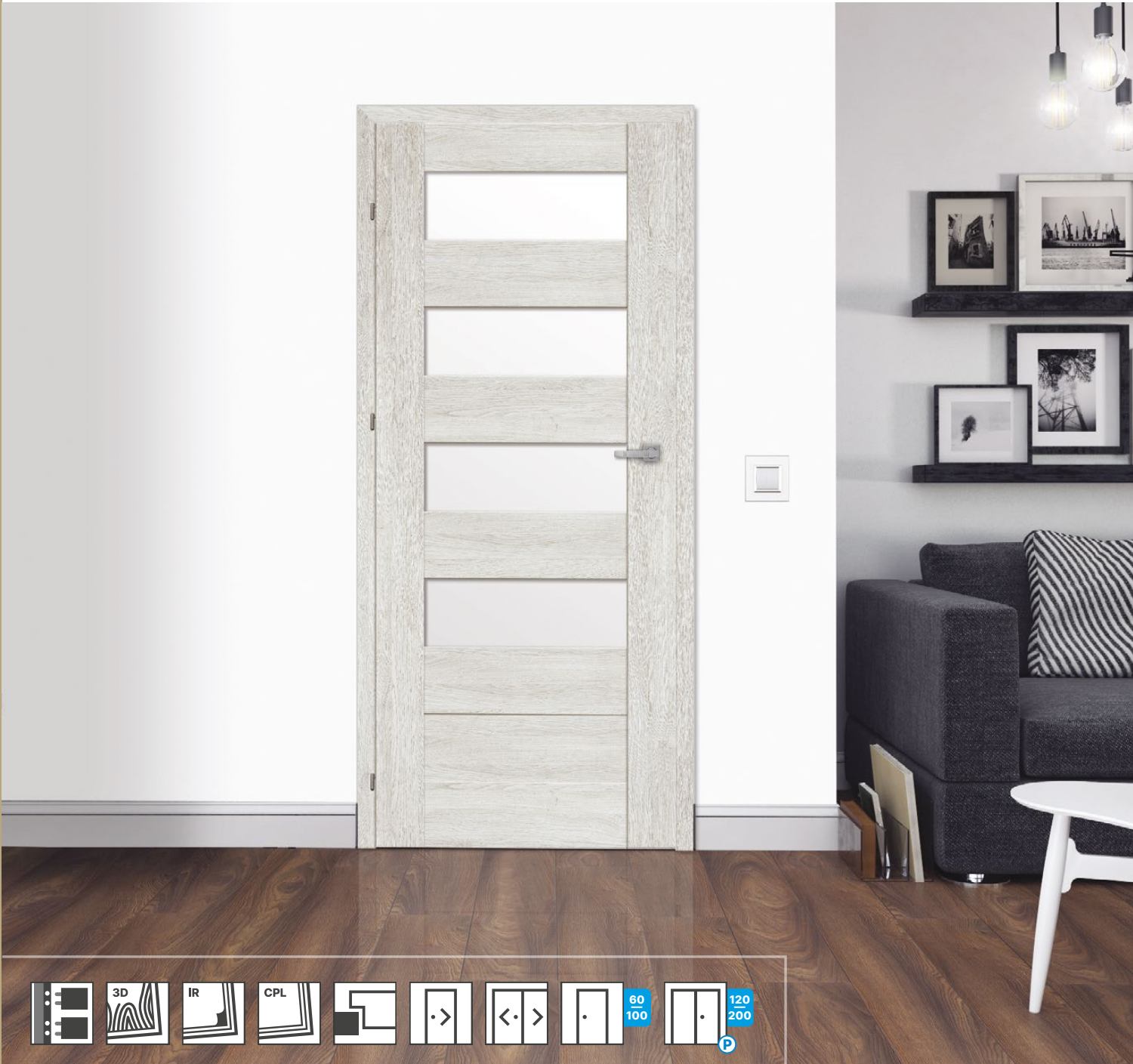

DOOR SPECIFICATION

- frame elements made of MDF board
- satin glass or HDF panel in the door leaf colour, thickness 4 mm

Rebated door leaf:

- three silver screw-in hinges
- lock: mortice key lock / bathroom lock / cylinder lock / passage lock

DEDICATED DOOR FRAMES

Hard edge K:

- fixed and adjustable door frames for rebated doors

EXTRA-COST OPTIONS

Ventilation:

- ventilation undercut
- ventilation undercut 15 mm (recuperation)

Construction:

- door leaf 100'
- sliding and passive door leaf

¹ | Decor is available while stocks last.



model 1



model 2



model 3



model 4



model 5



model 6



model 7

MODELS

DETAILS



satin glass

3D LOOK



RIVIERA OAK



WHITE ASH



COLOMBIA LIGHT WALNUT



OILED OAK

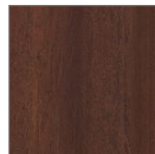

BURNT OAK¹



GRAY OAK

3D LOOK

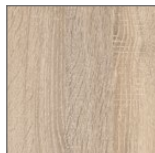

SONOMA OAK



ANTHRACITE OAK

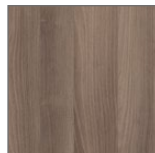

GRAPHITE ASH

IRIDIUM



WHITE MATT



NORWEGIAN ASH

CPL

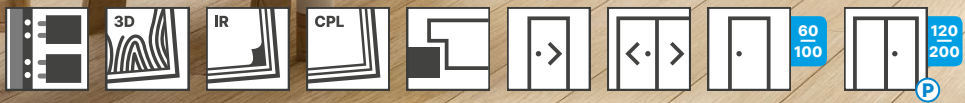

DOOR SPECIFICATION

- frame elements made of MDF board
- satin glass or HDF panel in the door leaf colour, thickness 4 mm

Rebated door leaf:

- three silver screw-in hinges
- lock: mortice key lock / bathroom lock / cylinder lock / passage lock

DEDICATED DOOR FRAMES

Hard edge K:

- fixed and adjustable door frames for rebated doors

EXTRA-COST OPTIONS

Ventilation:

- ventilation undercut
- ventilation undercut 15 mm (recuperation)

Construction:

- door leaf 100'
- sliding and passive door leaf

¹ | Decor is available while stocks last.



model 1



model 2

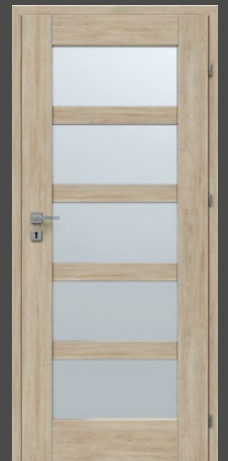

model 3



model 4



model 5

MODELS

DETAILS

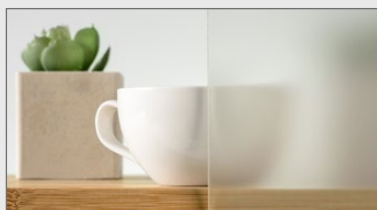

satin glass

3D LOOK

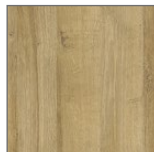

RIVIERA OAK



WHITE ASH



COLOMBIA LIGHT WALNUT

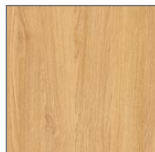

OILED OAK

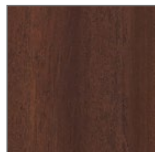

BURNT OAK¹



ANTHRACITE OAK

IRIDIUM

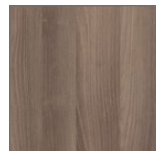

GRAPHITE ASH



WHITE MATT



MARONE OAK



NORWEGIAN ASH

CPL

TOSCA

VENEER FRAMED DOORS REBATED



60
100



120
200

DOOR SPECIFICATION

- frame elements made of MDF board
- satin glass or HDF panel in the door leaf colour, thickness 4 mm

Rebated door leaf:

- three silver screw-in hinges
- lock: mortice key lock / bathroom lock / cylinder lock / passage lock

DEDICATED DOOR FRAMES

Hard edge K:

- fixed and adjustable door frames for rebated doors

EXTRA-COST OPTIONS

Ventilation:

- ventilation undercut
- ventilation undercut 15 mm (recuperation)

Construction:

- door leaf 100'
- sliding and passive door leaf

¹ | Decor is available while stocks last.



model 1



model 2



model 3



model 4



model 5



model 6



model 7



model 8

MODELS

DETAILS

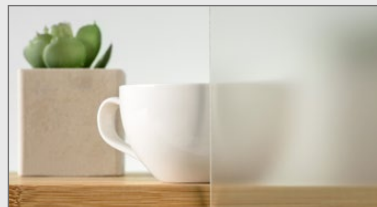

satin glass

3D LOOK

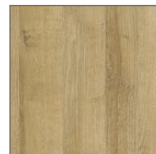

RIVIERA OAK



WHITE ASH

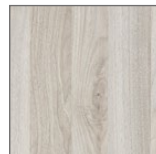

COLOMBIA LIGHT WALNUT

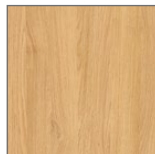

OILED OAK

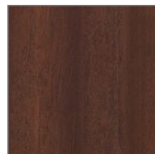

BURNT OAK¹



GRAY OAK

3D LOOK

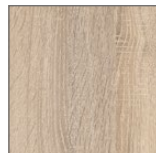

SONOMA OAK



ANTHRACITE OAK

IRIDIUM

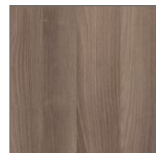

GRAPHITE ASH



WHITE MATT



MARONE OAK

CPL



NORWEGIAN ASH

FERRO

VENEER FRAMED DOORS REBATED / NON-REBATED



DOOR SPECIFICATION

- frame elements: peripheral frame made of softwood, chipboard core
- milky-white toughened safety glass or a board with the thickness of 17 mm
- model 3 with a mirror, on inner or outer side

Rebated door leaf:

- three silver screw-in hinges
- lock: mortice key lock / bathroom lock / cylinder lock / passage lock

Non-rebated door leaf:

- two openings for 3D hidden hinges
- magnetic lock: mortice key lock / bathroom lock / cylinder lock / passage lock

DEDICATED DOOR FRAMES

Hard edge K:

- fixed and adjustable door frames for rebated doors

Hard edge B:

- adjustable non-rebated door frame

EXTRA-COST OPTIONS

Ventilation:

- ventilation undercut
- ventilation undercut 15 mm (recuperation)

Construction:

- non-rebated door leaf
- door leaf 100'
- sliding door leaf



model 1

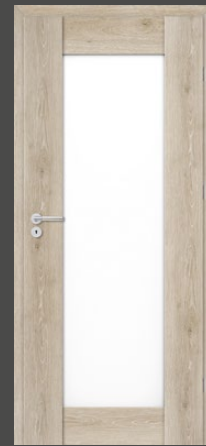

model 2

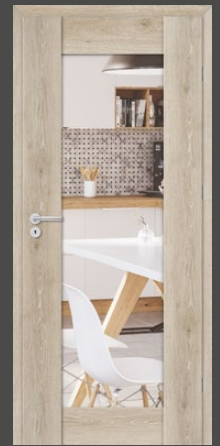

model 3 (with a mirror on one side)

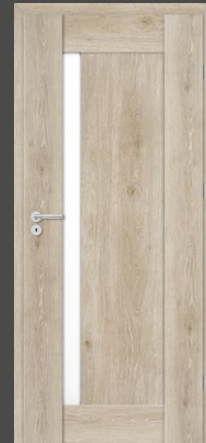

model 4



Door leaf cross-section

MODELS

DETAILS

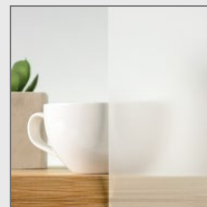

milky-white toughened safety glass



mirror

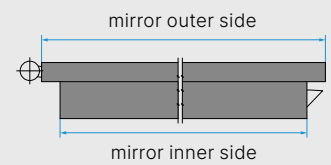

IRIDIUM

CPL

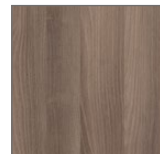

GRAPHITE ASH



ITALIAN WALNUT



LIGHT ACACIA



NORWEGIAN ASH



GRIGIO OAK



KENDAL OAK

KOFANO

VENEER FRAMED DOORS REBATED



DOOR SPECIFICATION

- frame elements made of MDF board
- satin glass, thickness 4 mm (milky-white toughened glass for models 1.2 and 1.4) or coffering

Rebated door leaf:

- three silver screw-in hinges
- lock: mortice key lock / bathroom lock / cylinder lock / passage lock

DEDICATED DOOR FRAMES

Hard edge K:

- fixed and adjustable door frames for rebated doors

EXTRA-COST OPTIONS

Ventilation:

- ventilation undercut
- ventilation undercut 15 mm (recuperation)

Construction:

- door leaf 100'
- sliding and passive door leaf

¹ | Decor is available while stocks last.



model 1.1



model 1.2



model 1.3



model 1.4



model 1.5



model 1.6



model 1.7

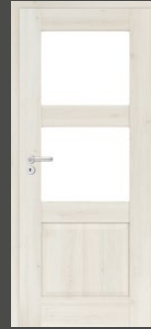

model 1.8



model 1.9



model 1.10



model 1.11



model 1.12



model 1.13

MODELS

DETAILS



satin glass

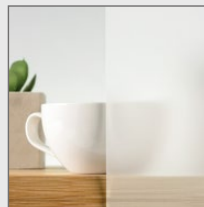

milky-white toughened
safety glass
(model: 1.2, 1.4)



coffering profile

3DLOOK

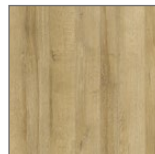

RIVIERA OAK



WHITE ASH



COLOMBIA LIGHT
WALNUT



OILED OAK

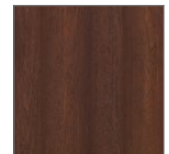

BURNT OAK ¹

3DLOOK



ANTHRACITE OAK

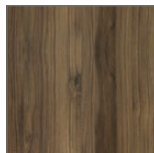

CATANIA OAK

IRIDIUM

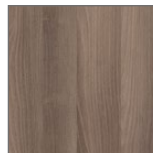

GRAPHITE ASH



WHITE MATT

CPL



NORWEGIAN ASH



VENEER PANEL DOORS

veneer panel doors

Universal and thus guaranteeing versatile use. They are perfect for every room - from the kitchen and living room to the bathroom. Thanks to them it is possible to create a coherent design of the entire apartment or house. The veneers covering the door leaves are durable and scratch resistant. Their advantage is also the variety of designs that fit into current trends and beautifully imitate the wood texture. You can find there not only classic beige and brown, but also shades of white, gray or anthracite. This rich palette of decors allows you to easily adapt them to any style of arrangement.



A SCANDINAVIAN INTERIOR WITH A TOUCH OF BOHO. An interesting combination for those, who are looking for a way to break the simplicity of Scandinavian style. It is worth complementing the arrangement by using a door with white veneer, imitating wood texture.

CLASSIC DECOR DOESN'T HAVE TO BE BORING. Are you looking for timeless yet distinctive doors? Choose the door leaves with veneered surface. You can choose from many different colours. You will surely find the one that will create a coherent composition together with other elements of the decor.



MODUL NEW!

VENEER PANEL DOORS REBATED / NON-REBATED



DOOR SPECIFICATION

- peripheral frame made of softwood
- application: MDF insert with a thickness of 31 mm in three widths: 40 mm, 80 mm, 154 mm

Rebated door leaf:

- three silver screw-in pintle hinges
- lock: mortice key lock / bathroom lock / cylinder lock / passage lock ¹

Non-rebated door leaf: ²

- two openings for 3D hidden hinges
- magnetic lock: mortice key lock / bathroom lock / cylinder lock / passage lock
- ABS edging as standard, for UNI White and UNI Black decors **DURABLE EDGING**

DEDICATED DOOR FRAMES

Hard edge K:

- adjustable door frames
- fixed door frames (except Hamilton Oak decor)

Hard edge B:

- non-rebated adjustable door frame

EXTRA-COST OPTIONS

Ventilation:

- ventilation undercut
- ventilation undercut 15 mm (recuperation)

Construction:

- door leaf 100'
- non-rebated door leaf
- sliding and passive door leaf

¹ | For the Uni Black decor, black locks.

² | For the Uni Black decor, black hinges and locks. Black hinges only in a set with a door frame in Uni Black.

³ | Hamilton Oak decor available only with an adjustable door frame.



model 1c

model 2c

model 3c



model 1h

model 2h

model 3h

model 1h

model 2h

model 3h

MODELS

DETAILS

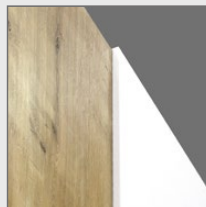

veneered insert
h - Hamilton Oak



veneered insert
b - UNI White



veneered insert
c - UNI Black

IRIDIUM



UNI WHITE



UNI BLACK



HAMILTON OAK ³

EXPLANATION OF MODEL DESCRIPTIONS

- b – Uni White insert
- c – Uni Black insert
- h – Hamilton Oak insert

DARK NEW!

VENEER PANEL DOORS REBATED / NON-REBATED



DOOR SPECIFICATION

- reinforced peripheral frame made of MDF
- application: gold aluminum profile, width: 8 mm, aligned with a door leaf surface

Rebated door leaf:

- three silver screw-in pintle hinges
- lock: mortice key lock / bathroom lock / cylinder lock / passage lock ¹

Non-rebated door leaf: ²

- two openings for 3D hidden hinges
- magnetic lock: mortice key lock / bathroom lock / cylinder lock / passage lock
- ABS edging as standard **DURABLE EDGING**

DEDICATED DOOR FRAMES

Hard edge K:

- fixed and adjustable door frames

Hard edge B:

- non-rebated adjustable door frame

EXTRA-COST OPTIONS

Ventilation:

- ventilation undercut
- ventilation undercut 15 mm (recuperation)

Construction:

- door leaf 100'
- non-rebated door leaf
- sliding and passive door leaf

¹ | For the Uni Black decor, black locks.

² | For the Uni Black decor, black hinges and locks. Black hinges only in a set with a door frame in Uni Black.

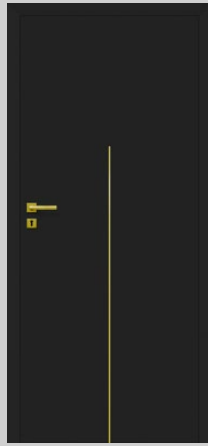

model 1

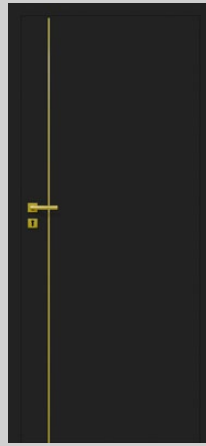

model 2



model 3

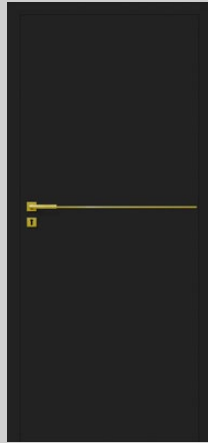

model 4



model 5

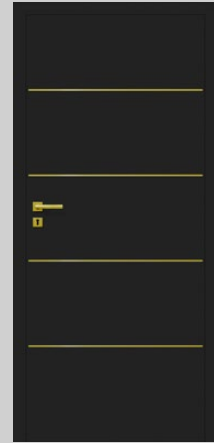

model 6

MODELS

DETAILS



gold aluminum profile,
8 mm

IRIDIUM



UNI BLACK



DOOR SPECIFICATION

- reinforced peripheral frame made of MDF
- application: gold or black aluminum profile, width: 8 mm, aligned with a door leaf surface

Rebated door leaf:

- three silver screw-in pintle hinges
- lock: mortice key lock / bathroom lock / cylinder lock / passage lock

Non-rebated door leaf:

- two openings for 3D hidden hinges
- magnetic lock: mortice key lock / bathroom lock / cylinder lock / passage lock
- ABS edging as standard

DURABLE EDGING

DEDICATED DOOR FRAMES

Hard edge K:

- fixed and adjustable door frames

Hard edge B:

- non-rebated adjustable door frame

EXTRA-COST OPTIONS

Ventilation:

- ventilation undercut
- ventilation undercut 15 mm (recuperation)

Construction:

- door leaf 100'
- non-rebated door leaf
- sliding and passive door leaf

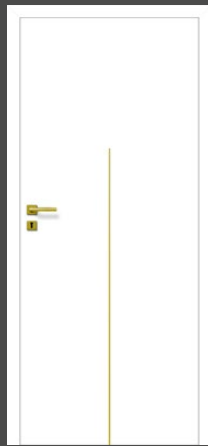

model 1z



model 2z

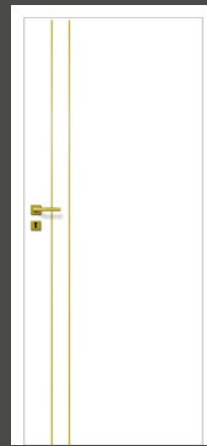

model 3z

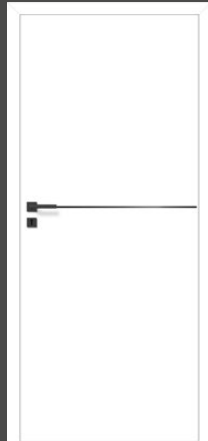

model 4c

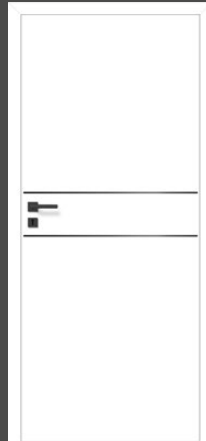

model 5c

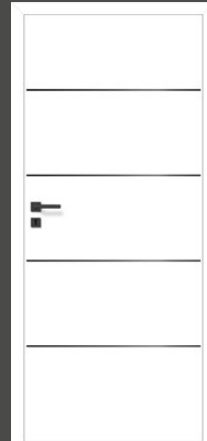

model 6c

MODELS

DETAILS



gold aluminum - z
profile, 8 mm



black aluminum - c
profile, 8 mm

IRIDIUM

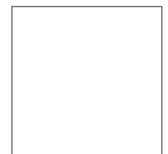

UNI WHITE

EXPLANATION OF MODEL DESCRIPTIONS

z – gold aluminum profile
c – black aluminum profile



DOOR SPECIFICATION

- reinforced peripheral frame made of MDF
- application: black aluminum profile, width: 8 mm, aligned with a door leaf surface
- models 1-3 available in decor with vertical graining
- models 4-6 available in decor with horizontal graining

Rebated door leaf:

- three silver screw-in pintle hinges
- lock: mortice key lock / bathroom lock / cylinder lock / passage lock

Non-rebated door leaf:

- two openings for 3D hidden hinges
- magnetic lock: mortice key lock / bathroom lock / cylinder lock / passage lock

DEDICATED DOOR FRAMES

Hard edge K:

- rebated adjustable door frame

Hard edge B:

- non-rebated adjustable door frame

EXTRA-COST OPTIONS

Ventilation:

- ventilation undercut
- ventilation undercut 15 mm (recuperation)

Construction:

- door leaf 100'
- non-rebated door leaf
- sliding and passive door leaf

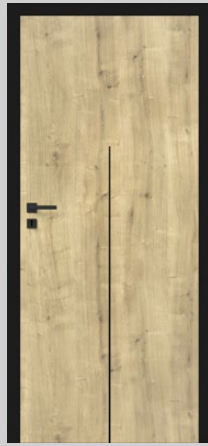

model 1

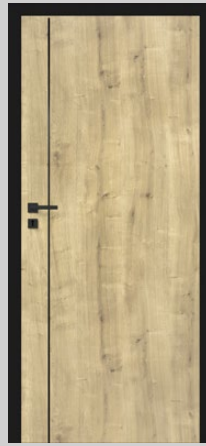

model 2

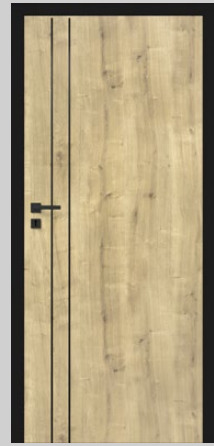

model 3



model 4



model 5

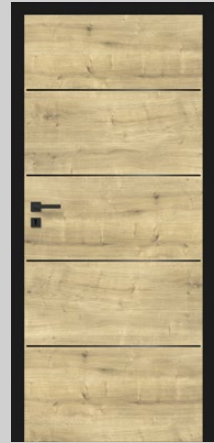

model 6

MODELS

DETAILS



black aluminum profile, 8 mm

CPL

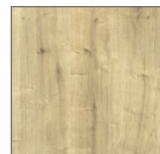

HAMILTON OAK VERTICAL



HAMILTON OAK HORIZONTAL



DOOR SPECIFICATION

- Classen Hard construction
- milky-white toughened glass

Rebated door leaf:

- two silver screw-in pintle hinges ¹
- lock: mortice key lock / bathroom lock / cylinder lock / passage lock ²

Non-rebated door leaf: ³

- two openings for 3D hidden hinges
- magnetic lock: mortice key lock / bathroom lock / cylinder lock / passage lock
- ABS edging as standard, for UNI White and UNI Black decors

DURABLE EDGING

DEDICATED DOOR FRAMES

Hard edge K:

- adjustable door frames
- fixed door frames (except Hamilton Oak decor)

Hard edge B:

- non-rebated adjustable door frame

EXTRA-COST OPTIONS

Ventilation:

- ventilation undercut
- ventilation undercut 15 mm (recuperation)

Glazing:

- transparent glass

Construction:

- third hinge
- perforated chipboard
- non-rebated door leaf (HB)
- door leaf 100'
- sliding and passive door leaf

¹ | Door leaves 100' and reinforced door leaves regardless of the size – the set includes 3 hinges.

² | For the Uni Black decor, black locks.

³ | For the Uni Black decor, black hinges and locks. Black hinges only in a set with a door frame in Uni Black.

⁴ | Hamilton Oak decor available only with an adjustable door frame.

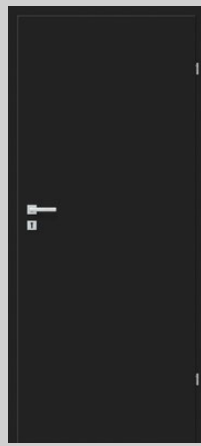

model 1



model 2



model 3



model 4



model 5



model 6

MODELS

DETAILS

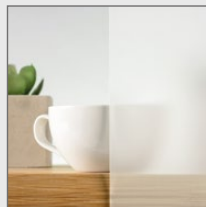

milky-white
toughened glass



glazing frame

IRIDIUM



UNI WHITE



UNI BLACK



MARONE OAK

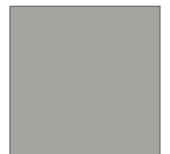

GRAY MATT

CPL



ACACIA LIGHT



NORWEGIAN ASH



GRIGIO OAK

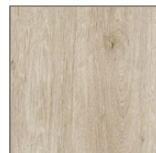

KENDAL OAK



HAMILTON OAK ⁴

SAGA

VENEER PANEL DOORS REBATED / NON-REBATED



DOOR SPECIFICATION

- peripheral frame made of softwood
- detail: aluminum profile, width: 8 mm, aligned with a door leaf surface

Rebated door leaf:

- three silver screw-in pintle hinges
- lock: mortice key lock / bathroom lock / cylinder lock / passage lock

Non-rebated door leaf:

- two openings for 3D hidden hinges
- magnetic lock: mortice key lock / bathroom lock / cylinder lock / passage lock

DEDICATED DOOR FRAMES

Hard edge K:

- fixed and adjustable door frames for rebated doors

Hard edge B:

- adjustable non-rebated door frame

EXTRA-COST OPTIONS

Ventilation:

- ventilation undercut
- ventilation undercut 15 mm (recuperation)
- ventilation sleeves – PVC

Construction:

- door leaf 100'
- non-rebated door leaf
- sliding and passive door leaf

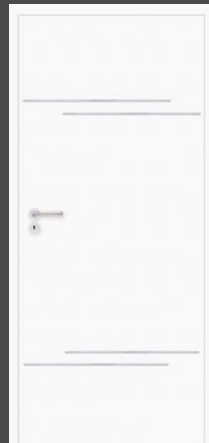

model 1 / 1a / 1b

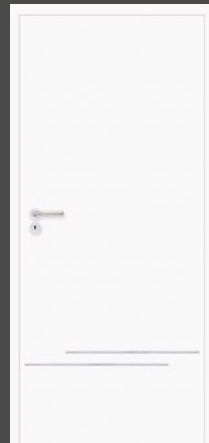

model 2 / 2a / 2b



model 3 / 3a / 3b

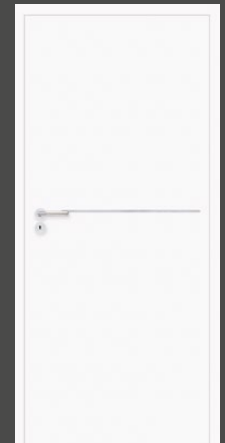

model 4 / 4a / 4b



model 5 / 5a / 5b



model 6 / 6a / 6b

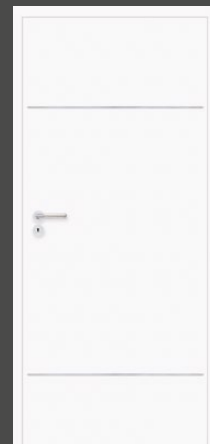

model 7 / 7a / 7b

MODELS

DETAILS



aluminum profile, 8 mm



rebate finish
in white decor
(models 1-7)



rebate finish
in aluminum decor
(models 1a-7a)



rebate finish
in plywood decor
(models 1b-7b)

CPL



WHITE
RAL 9003



WHITE WITH
HORIZONTAL
STRUCTURE

ASTERIA NL

VENEER PANEL DOORS REBATED / NON-REBATED



DOOR SPECIFICATION

- peripheral frame made of softwood
- opaque graphite painted glass

Rebated door leaf:

- three silver screw-in pintle hinges
- lock: mortice key lock / bathroom lock / cylinder lock / passage lock

Non-rebated door leaf:

- two openings for 3D hidden hinges
- magnetic lock: mortice key lock / bathroom lock / cylinder lock / passage lock

DEDICATED DOOR FRAMES

Hard edge K:

- adjustable door frames
- fixed door frames (except Hamilton Oak decor)

Hard edge B:

- adjustable non-rebated door frame

EXTRA-COST OPTIONS

Ventilation:

- ventilation undercut
- ventilation undercut 15 mm (recuperation)
- ventilation sleeves – PVC
- ventilation sleeves – satin chrome steel

Construction:

- door leaf 100'
- non-rebated door leaf
- sliding and passive door leaf

¹ | Decor is available while stocks last.



model 1



model 2



model 3



model 4



model 5



model 6



model 7



model 8



model 9

MODELS

DETAILS

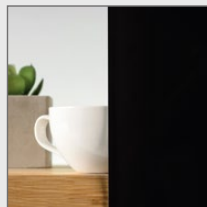

graphite painted glass, aligned with a door leaf surface

IRIDIUM

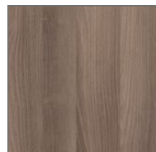

GRAPHITE ASH



SNOW ASH¹



ITALIAN WALNUT



LIGHT ACACIA



NORWEGIAN ASH



GRIGIO OAK

CPL



HAMILTON OAK VERTICAL



HAMILTON OAK HORIZONTAL

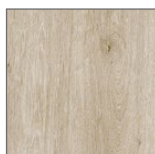

KENDAL OAK



WHITE RAL 9003



GRAY RAL 7047



GRAPHITE RAL 7024

DISCOVERY

VENEER PANEL DOORS REBATED / NON-REBATED



DOOR SPECIFICATION

- Hard Edge R door leaf edge profile for Iridium decors, peripheral frame made of softwood ¹
- Hard Edge PF door leaf edge profile for CPL decors, peripheral frame made of MDF board, reinforced ¹
- detail: aluminum profile, width: 8 mm, aligned with a door leaf surface
- milky-white toughened glass with transparent overprint

Rebated door leaf:

- three silver screw-in pintle hinges
- lock: mortice key lock / bathroom lock / cylinder lock / passage lock

Non-rebated door leaf:

- two openings for 3D hidden hinges
- magnetic lock: mortice key lock / bathroom lock / cylinder lock / passage lock

DEDICATED DOOR FRAMES

Hard edge PF/R:

- adjustable door frames
- fixed door frames (except Hamilton Oak decor)

Hard edge B:

- adjustable non-rebated door frame

EXTRA-COST OPTIONS

Ventilation:

- ventilation undercut
- ventilation undercut 15 mm (recuperation)
- ventilation sleeves – satin chrome steel

Construction:

- door leaf 100'
- non-rebated door leaf
- sliding and passive door leaf

¹ | Perforated chipboard core (models 4–11), Classen Hard construction (models 1–3).

² | Hard Edge PF door construction for CPL decors.

³ | Decor is available while stocks last.

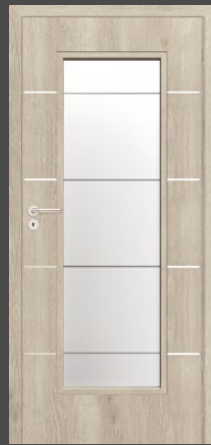

model 1



model 2

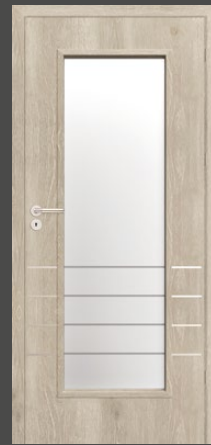

model 3



model 4



model 5



model 6



model 10



model 11

MODELS

DETAILS



milky-white toughened glass with transparent overprint



glazing frame



aluminum profile 8mm

IRIDIUM

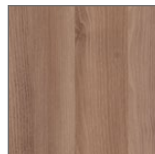

BROWN ASH

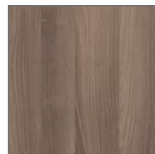

GRAPHITE ASH



SNOW ASH ³



HAMILTON OAK HORIZONTAL

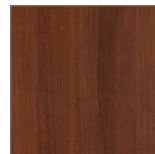

ITALIAN WALNUT



LIGHT ACACIA

CPL ²



NORWEGIAN ASH



GRIGIO OAK

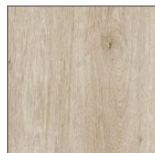

KENDAL OAK



WHITE RAL 9003



WHITE WITH HORIZONTAL STRUCTURE

TETYDA

VENEER PANEL DOORS REBATED / NON-REBATED

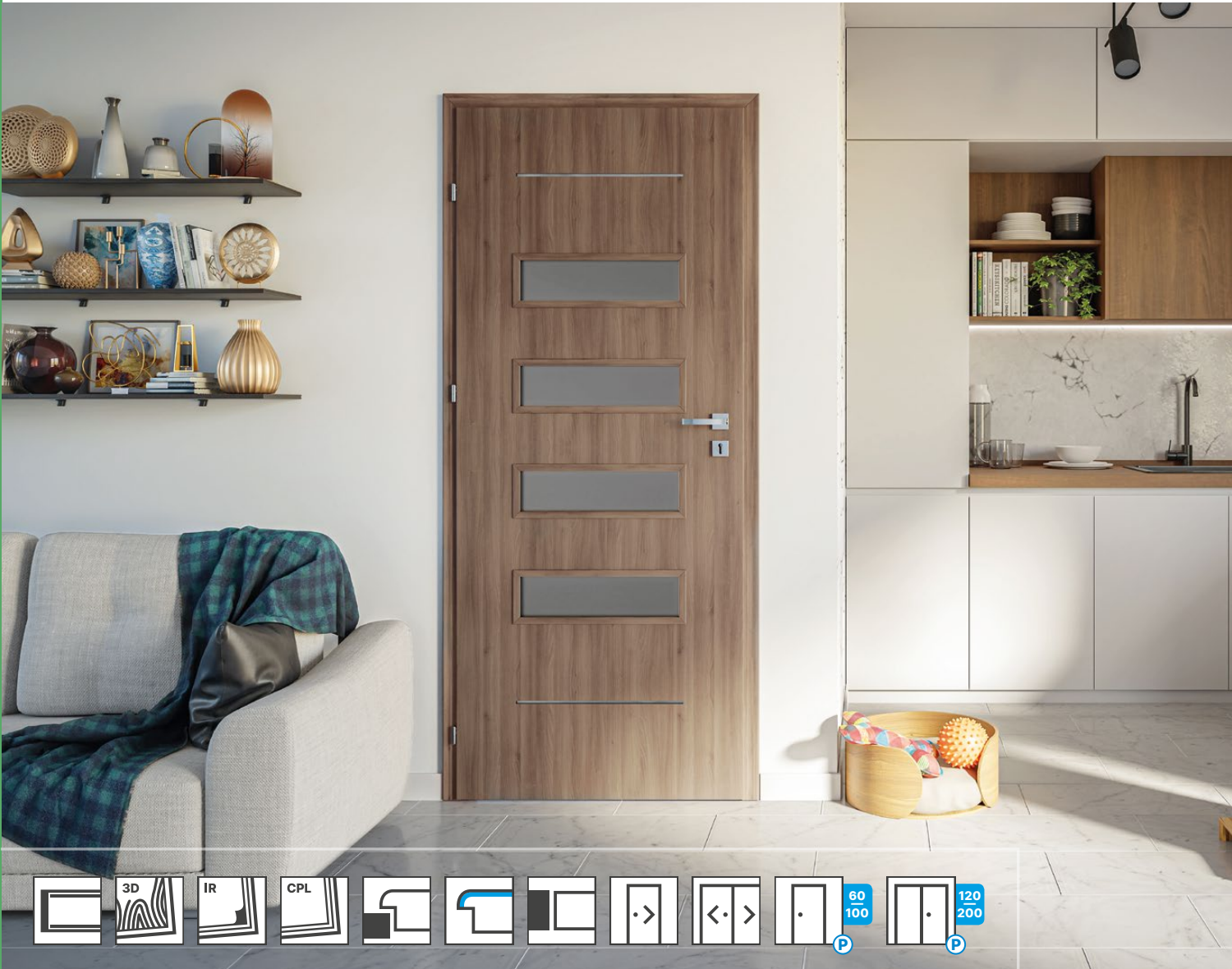

DOOR SPECIFICATION

- Hard Edge R door leaf edge profile for 3D Look and Iridium decors, Classen Hard construction / peripheral frame made of softwood
- Hard Edge PF door leaf edge profile for CPL decors, Classen Hard construction / peripheral frame made of MDF board, reinforced
- detail: aluminum profile, width: 6 mm
- safety toughened Estriado glass, brown satin, graphite satin

Rebated door leaf:

- two silver screw-in pintle hinges ¹
- lock: mortice key lock / bathroom lock / cylinder lock / passage lock

Non-rebated door leaf:

- Classen Hard construction / peripheral frame made of softwood
- two openings for 3D hidden hinges
- magnetic lock: mortice key lock / bathroom lock / cylinder lock / passage lock

DEDICATED DOOR FRAMES

Hard edge PF/R:

- fixed and adjustable door frames for rebated doors

Hard edge B:

- adjustable non-rebated door frame

EXTRA-COST OPTIONS

Ventilation:

- ventilation undercut
- ventilation undercut 15 mm (recuperation)
- ventilation sleeves – PVC

Construction:

- door leaf 100'
- third hinge
- reinforced with perforated chipboard ²
- non-rebated door leaf
- sliding and passive door leaf

¹ | Door leaves 100' and reinforced door leaves regardless of the size – the set includes 3 hinges.

² | No Hard reinforcement.

³ | Non-rebated model is not available in marked decors.

⁴ | Hard Edge PF door construction for CPL decors.

⁵ | Decor is available while stocks last.



model 1

model 2

model 3

model 4

model 5

MODELS

DETAILS

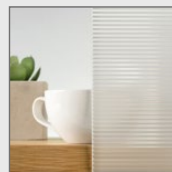

estriado glass

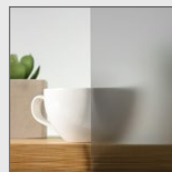

graphite satin glass

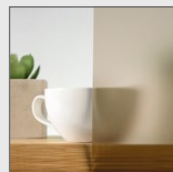

brown satin glass



glazing frame



aluminum profile 6 mm

3DLOOK³

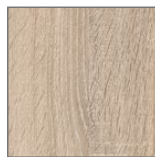

SONOMA OAK



RIVIERA OAK



COLOMBIA LIGHT WALNUT



WHITE ASH



GRAY OAK

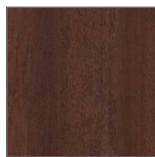

BURNT OAK

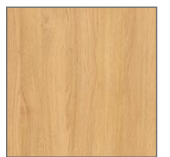

OILED OAK

IRIDIUM

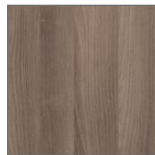

GRAPHITE ASH

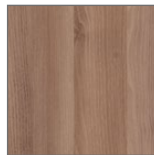

BROWN ASH



SNOW ASH⁵

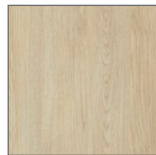

MARONE OAK



WENGE³

CPL⁴



NORWEGIAN ASH



GRIGIO OAK

CPL⁴

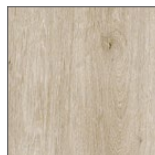

KENDAL OAK

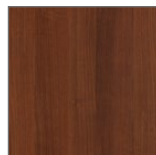

ITALIAN WALNUT



LIGHT ACACIA



WHITE RAL 9003



WHITE WITH HORIZONTAL STRUCTURE

NATURA HR

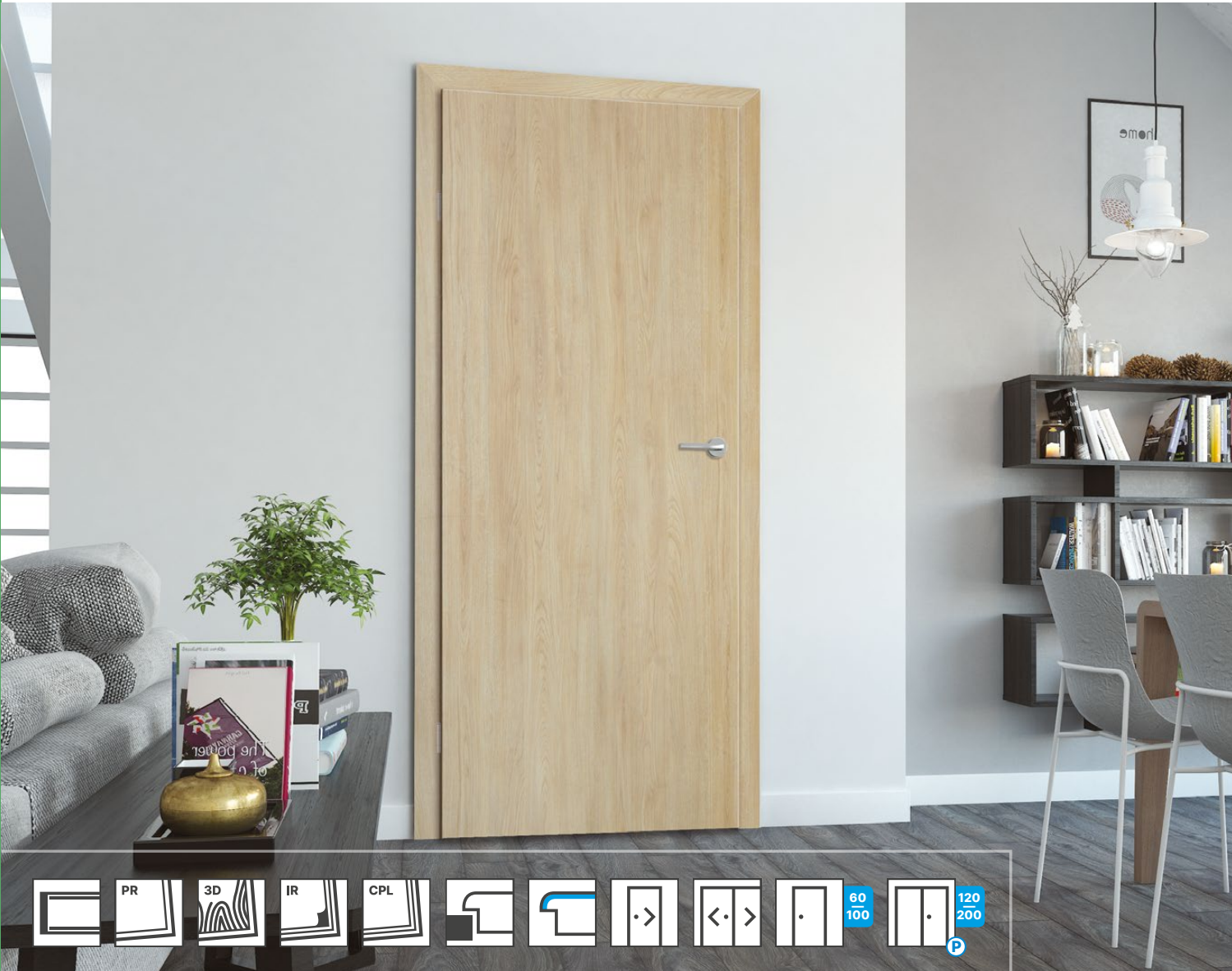

DOOR SPECIFICATION

Rebated door leaf:

- Hard Edge R door leaf edge profile for Primo, 3D Look and Iridium decors, Classen Hard construction / peripheral frame made of softwood
- Hard Edge PF door leaf edge profile for CPL decors, peripheral frame made of MDF board, reinforced, Classen Hard construction
- two silver screw-in pintle hinges ¹
- lock: mortice key lock / bathroom lock / cylinder lock / passage lock
- milky-white toughened safety glass

DEDICATED DOOR FRAMES

Hard edge R/PF:

- adjustable door frames
- fixed door frames (except Hamilton Oak decor)

EXTRA-COST OPTIONS

Ventilation:

- ventilation undercut
- ventilation undercut 15 mm (recuperation)
- PVC ventilation sleeves

Glazing:

- porthole 35 ml (model 1)
- transparent glass (models 2–4)

Construction:

- third hinge
- perforated chipboard ²
- solid chipboard ²
- door leaf 100'
- sliding and passive door leaf

¹ Door leaves 100' and reinforced door leaves regardless of the size – the set includes 3 hinges.

² No Hard reinforcement.

³ Hard Edge PF door construction for CPL decors.

⁴ Decor available only for model 1.

⁵ Decor is available while stocks last.



model 1



model 2

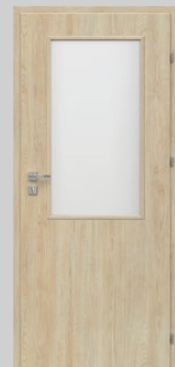

model 3



model 4

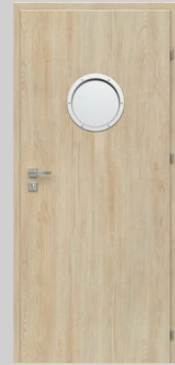

model 1
with porthole

Door leaf with porthole is not available in sliding version, more on page 150.

MODELS

DETAILS

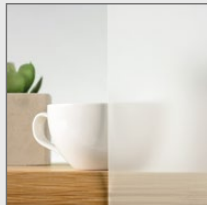

milky-white toughened safety glass



glazing frame profile

PRIMO

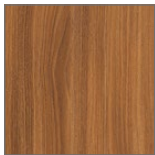

ACACIA ST



BEECH

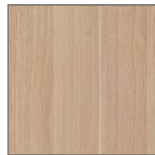

NATURAL OAK

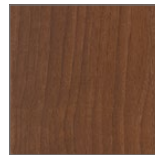

WALNUT

3D LOOK

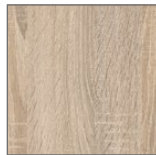

SONOMA OAK

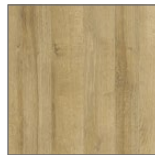

RIVIERA OAK



WHITE ASH



COLOMBIA LIGHT WALNUT

3D LOOK

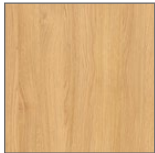

OILED OAK



BURNT OAK ⁵



GRAY OAK



CATANIA OAK

IRIDIUM

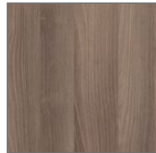

GRAPHITE ASH

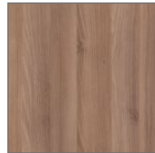

BROWN ASH



SNOW ASH ⁵



MARONE OAK

IRIDIUM



WENGE

CPL ³



HAMILTON OAK VERTICAL



NORWEGIAN ASH



GRIGIO OAK ⁴

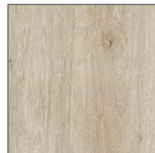

KENDAL OAK ⁴



WHITE RAL 9003



WHITE WITH HORIZONTAL STRUCTURE

ANDROMEDA

VENEER PANEL DOORS REBATED / NON-REBATED



DOOR SPECIFICATION

- peripheral frame made of softwood
- milky-white toughened safety glass

Rebated door leaf:

- three silver screw-in pintle hinges
- lock: mortice key lock / bathroom lock / cylinder lock / passage lock

Non-rebated door leaf:

- two openings for 3D hidden hinges
- magnetic lock: mortice key lock / bathroom lock / cylinder lock / passage lock

DEDICATED DOOR FRAMES

Hard edge R:

- adjustable door frames for rebated doors
- fixed door frames (except Hamilton Oak decor)

Hard edge B:

- adjustable non-rebated door frame

EXTRA-COST OPTIONS

Ventilation:

- ventilation undercut

Glazing:

- safety glass, graphite satin

Construction:

- door leaf 100'
- non-rebated door leaf



model 1



model 2



model 3



model 4



model 5

MODELS

DETAILS

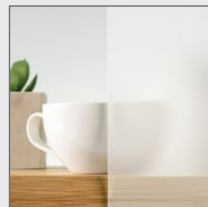

milky-white toughened safety glass

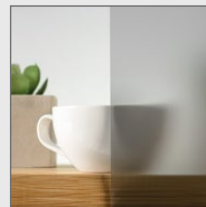

OPTION / graphite satin glass

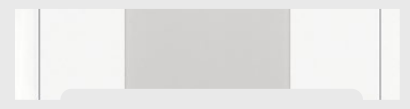

ventilation undercut available for all models

IRIDIUM

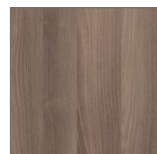

GRAPHITE ASH



WENGE



MARONE OAK



HAMILTON OAK VERTICAL

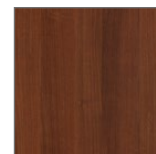

ITALIAN WALNUT



LIGHT ACACIA

CPL



NORWEGIAN ASH



GRIGIO OAK

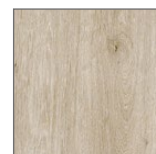

KENDAL OAK



WHITE RAL 9003



WHITE WITH HORIZONTAL STRUCTURE

DEMETER



DOOR SPECIFICATION

- Hard Edge R door leaf edge profile for Primo, 3D Look and Iridium decors, Classen Hard construction / peripheral frame made of softwood
- Hard Edge PF door leaf edge profile for CPL decors, Classen Hard construction / peripheral frame made of MDF board, reinforced
- milky-white toughened safety glass

Rebated door leaf:

- two silver screw-in pintle hinges ¹
- lock: mortice key lock / bathroom lock / cylinder lock / passage lock
- **NOTE** – single leaf
 - 60–100' (models 1 and 4)
 - 70'–100' (models 2, 3, 5)

DEDICATED DOOR FRAMES

Hard edge PF/R:

- adjustable door frames
- fixed door frames (except Hamilton Oak decor)

EXTRA-COST OPTIONS

Ventilation:

- ventilation undercut
- ventilation undercut 15 mm (recuperation)
- PVC ventilation sleeves

Construction:

- door leaf 100'
- third hinge
- reinforced with perforated chipboard ²
- sliding and passive door leaf

¹ Door leaves 100' and reinforced door leaves regardless of the size – the set includes 3 hinges.

² No Hard reinforcement.

³ Hard Edge PF door construction for CPL decors.

⁴ Decor is available while stocks last.



model 1

model 2

model 3

model 4

model 5

MODELS

DETAILS

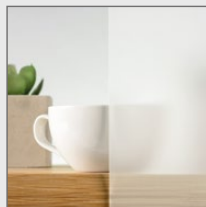

milky-white toughened safety glass



glazing frame

PRIMO

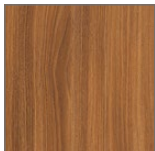

ACACIA ST



NATURAL OAK

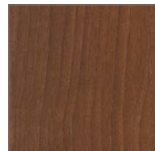

WALNUT

3D LOOK

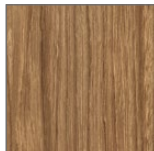

HONEY CATANIA

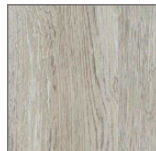

GESSATO OAK

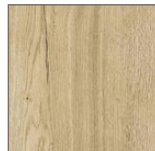

CLEVELAND OAK

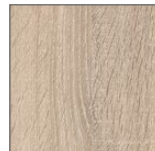

SONOMA OAK



OILED OAK

3D LOOK

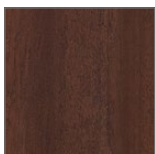

BURNT OAK ⁴



GRAY OAK

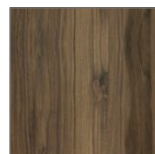

CATANIA OAK



RIVIERA OAK



COLOMBIA LIGHT WALNUT



WHITE ASH

IRIDIUM

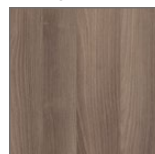

GRAPHITE ASH

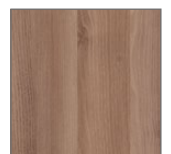

BROWN ASH

IRIDIUM



SNOW ASH ⁴



MARONE OAK



WENGE



GRAY MATT

CPL 3



NORWEGIAN ASH



HAMILTON OAK VERTICAL



GRIGIO OAK



KENDAL OAK

CPL 3

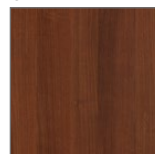

ITALIAN WALNUT



LIGHT ACACIA

ARENA

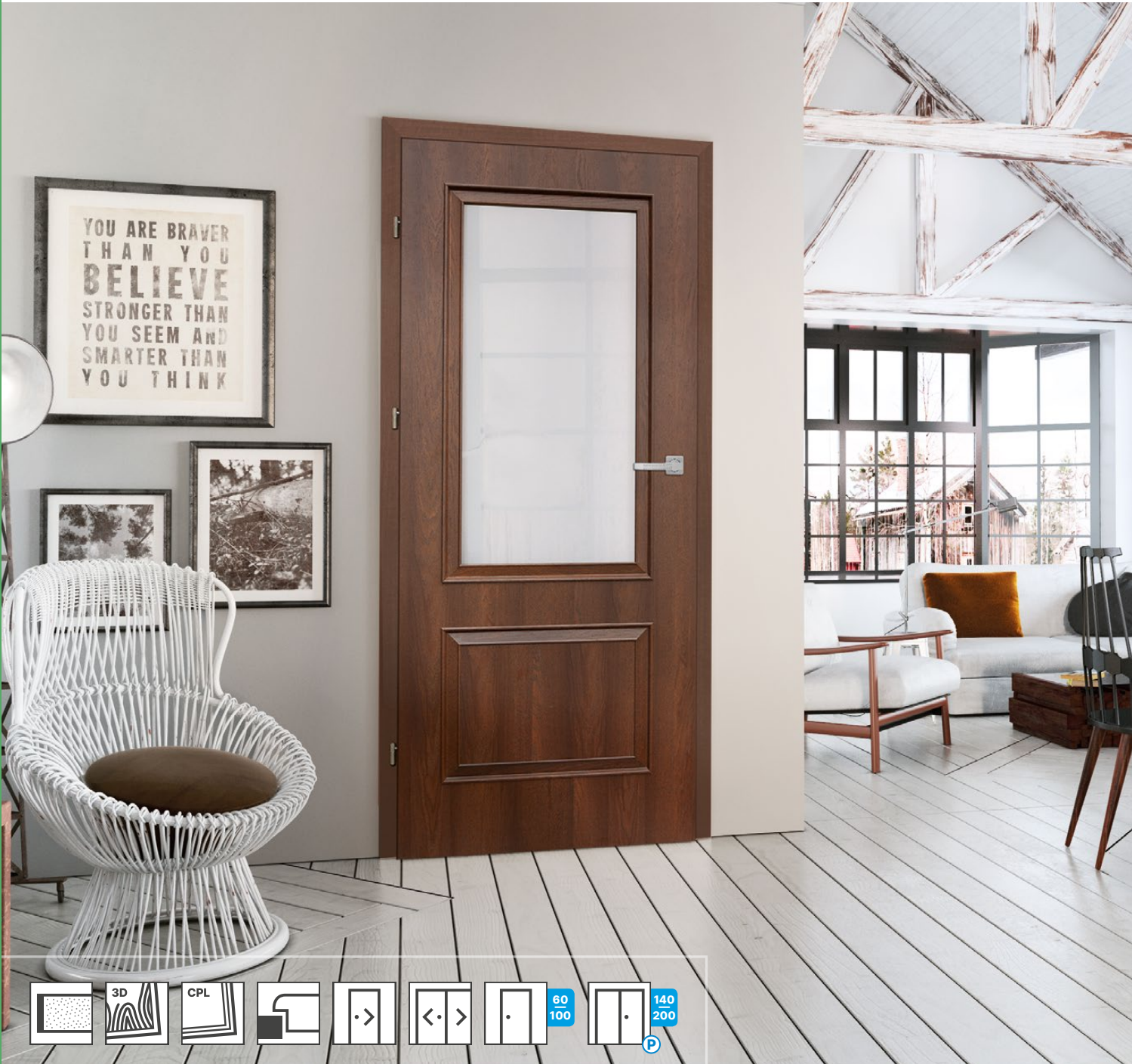

DOOR SPECIFICATION

- peripheral frame made of softwood
- satin glass

Rebated door leaf:

- three silver screw-in pintle hinges
- lock: mortice key lock / bathroom lock / cylinder lock / passage lock

DEDICATED DOOR FRAMES

Hard edge R:

- fixed and adjustable door frames for rebated doors

EXTRA-COST OPTIONS

Ventilation:

- ventilation undercut
- ventilation undercut 15 mm (recuperation)
- PVC ventilation sleeves

Glazing:

- satin glass, brown or graphite ²

Construction:

- door leaf 100'
- sliding and passive door leaf

¹ For model 4 Classen Hard construction.

² Extended delivery time.

³ Decor is available while stocks last.



model 1



model 2



model 3



model 4 ¹



model 5



model 6



model 7

MODELS

DETAILS

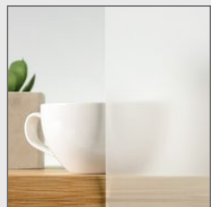

satin glass



OPTION / brown
satin glass



OPTION / graphite
satin glass



glazing frame

3D LOOK



WHITE ASH

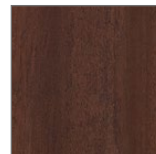

BURNT OAK ³



MARONE OAK

IRIDIUM

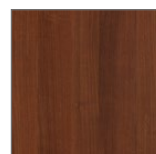

ITALIAN WALNUT



NORWEGIAN ASH

CPL

CENTURY

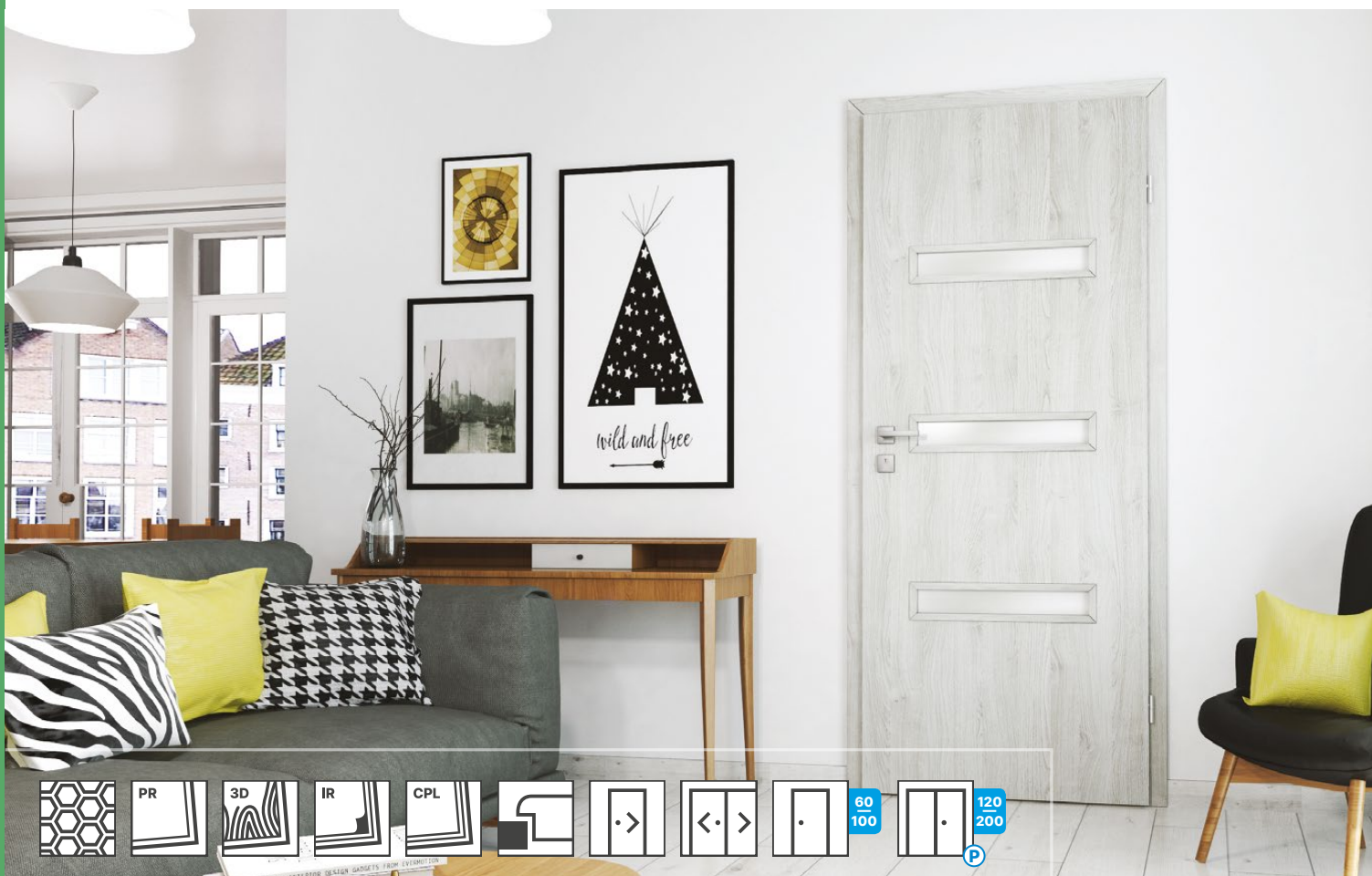

DOOR SPECIFICATION

- peripheral frame made of MDF board
- satin glass

Rebated door leaf:

- two silver screw-in pintle hinges ¹
- lock: mortice key lock / bathroom lock / cylinder lock / passage lock

DEDICATED DOOR FRAMES

Hard edge R:

- fixed and adjustable door frames for rebated doors

EXTRA-COST OPTIONS

Ventilation:

- ventilation undercut
- ventilation undercut 15 mm (recuperation)
- PVC ventilation sleeves

Glazing:

- satin glass, brown or graphite ²

Construction:

- door leaf 100'
- sliding and passive door leaf ³

¹ Door leaves 100' and reinforced door leaves regardless of the size – 3 hinges.

² Extended delivery time.

³ Passive doors are produced using peripheral frame made of softwood.

⁴ Decor is available while stocks last.

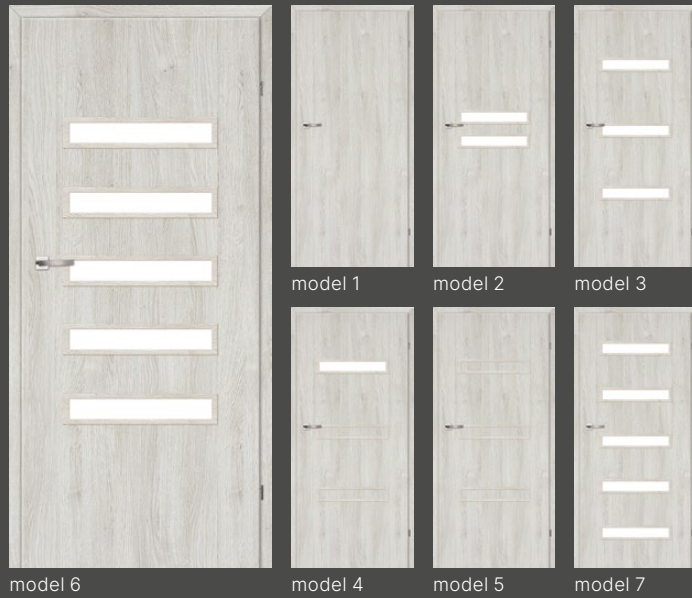

MODELS

DETAILS



satin glass

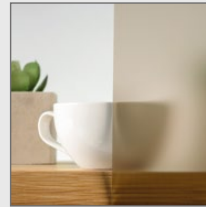

OPTION / brown satin glass

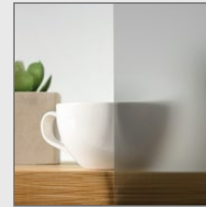

OPTION / graphite satin glass



glazing frame

PRIMO



ACACIA ST NATURAL OAK WALNUT WHITE

3D LOOK



HONEY CATANIA GESSATO OAK CLEVELAND OAK SONOMA OAK

3D LOOK



RIVIERA OAK COLOMBIA LIGHT WALNUT WHITE ASH OILED OAK BURNT OAK⁴ GRAY OAK ANTHRACITE OAK CATANIA OAK

IRIDIUM



GRAPHITE ASH BROWN ASH SNOW ASH⁴ MARONE OAK WENGE GRAY MATT

CPL

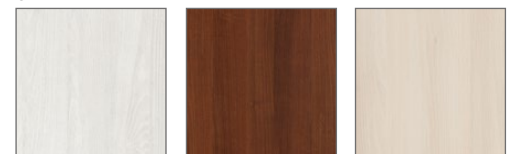

NORWEGIAN ASH ITALIAN WALNUT LIGHT ACACIA

MALAGA



DOOR SPECIFICATION

- peripheral frame made of MDF board
- milky-white toughened safety glass

Rebated door leaf:

- two silver screw-in pintle hinges ¹
- lock: mortice key lock / bathroom lock / cylinder lock / passage lock

DEDICATED DOOR FRAMES

Hard edge K:

- fixed and adjustable door frames for rebated doors

EXTRA-COST OPTIONS

Ventilation:

- ventilation grille
- PVC ventilation sleeves

Construction:

- door leaf 100'
- third hinge
- reinforced with perforated chipboard ²
- sliding and passive door leaf ²

¹ Door leaves 100' and reinforced door leaves regardless of the size – 3 hinges.

² Doors reinforced with perforated chipboard and passive doors are produced using peripheral frame made of softwood.

³ Decor is available while stocks last.



full



1/4 glass



2/4 glass



3/4 glass



4/4 glass

MODELS

DETAILS



milky-white toughened safety glass



glazing frame

PRIMO

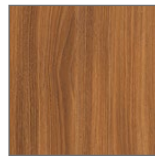

ACACIA ST

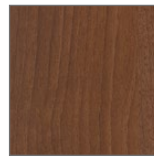

WALNUT



WHITE

3D LOOK

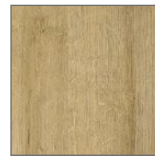

RIVIERA OAK



COLOMBIA LIGHT WALNUT

3D LOOK



WHITE ASH

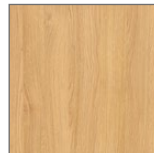

OILED OAK

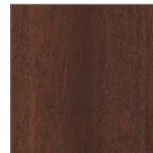

BURNT OAK³



GRAY OAK



CATANIA OAK

IRIDIUM



GRAPHITE ASH

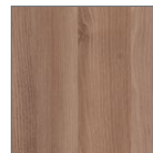

BROWN ASH



MARONE OAK



WENGE

MODENA 4

VENEER PANEL DOORS REBATED



DOOR SPECIFICATION

- peripheral frame made of MDF board
- milky-white toughened safety glass

Rebated door leaf:

- two silver screw-in pintle hinges ¹
- lock: mortice key lock / bathroom lock / cylinder lock / passage lock

DEDICATED DOOR FRAMES

Hard edge K:

- fixed and adjustable door frames for rebated doors

EXTRA-COST OPTIONS

Ventilation:

- ventilation grille
- PVC ventilation sleeves

Construction:

- door leaf 100'
- third hinge
- reinforced with perforated chipboard ²
- sliding and passive door leaf ²

¹ | Door leaves 100' and reinforced door leaves regardless of the size – 3 hinges.

² | Doors reinforced with perforated chipboard and passive doors are produced using peripheral frame made of softwood.



full



1/4 glass

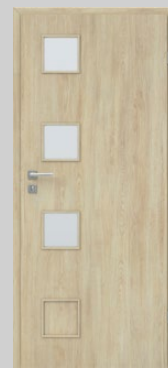

3/4 glass



4/4 glass

MODELS

DETAILS

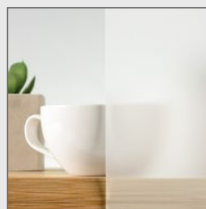

milky-white toughened safety glass



glazing frame

PRIMO

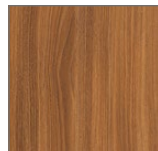

ACACIA ST

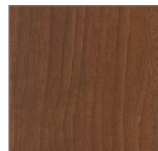

WALNUT



WHITE



RIVIERA OAK

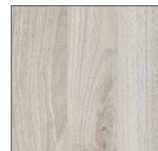

COLOMBIA LIGHT WALNUT



WHITE ASH

3D LOOK



GRAY OAK

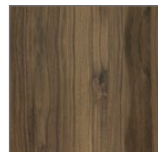

CATANIA OAK

IRIDIUM

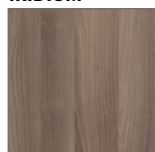

GRAPHITE ASH

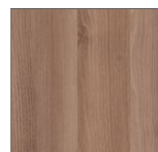

BROWN ASH



MARONE OAK

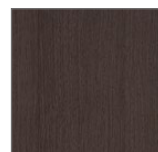

WENGE

NATURA



DOOR SPECIFICATION

- peripheral frame made of MDF board
- ornamental glass, transparent bark

Rebated door leaf:

- two silver screw-in pintle hinges ¹
- lock: mortice key lock / bathroom lock / cylinder lock / passage lock

DEDICATED DOOR FRAMES

Hard edge K:

- fixed and adjustable door frames for rebated doors

EXTRA-COST OPTIONS

Ventilation:

- ventilation grille
- PVC ventilation sleeves

Construction:

- door leaf 100'
- third hinge
- reinforced with perforated chipboard ³
- sliding and passive door leaf ³

¹ | Door leaves 100' and reinforced door leaves regardless of the size – 3 hinges.

² | Decor available only for full model.

³ | Doors reinforced with perforated chipboard and passive doors are produced using peripheral frame made of softwood.

⁴ | Decor is available while stocks last.



full



1/3 glass



2/3 glass



3/3 glass

MODELS

DETAILS



ornamental glass,
transparent bark



glazing frame

PRIMO

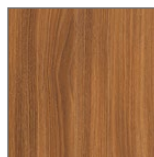

ACACIA ST ²



BEECH



NATURAL OAK ²

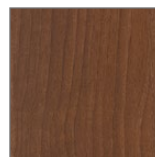

WALNUT



WHITE



POLISH OAK

3D LOOK



RIVIERA OAK ²



COLOMBIA LIGHT
WALNUT



WHITE ASH



OILED OAK

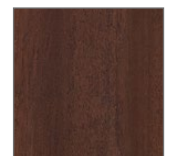

BURNT OAK ^{2,4}

3D LOOK



GRAY OAK

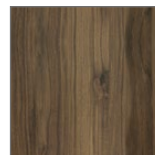

CATANIA OAK



WENGE ²

IRIDIUM



GRAY MATT ²

ANTIOPE

VENEER PANEL DOORS REBATED

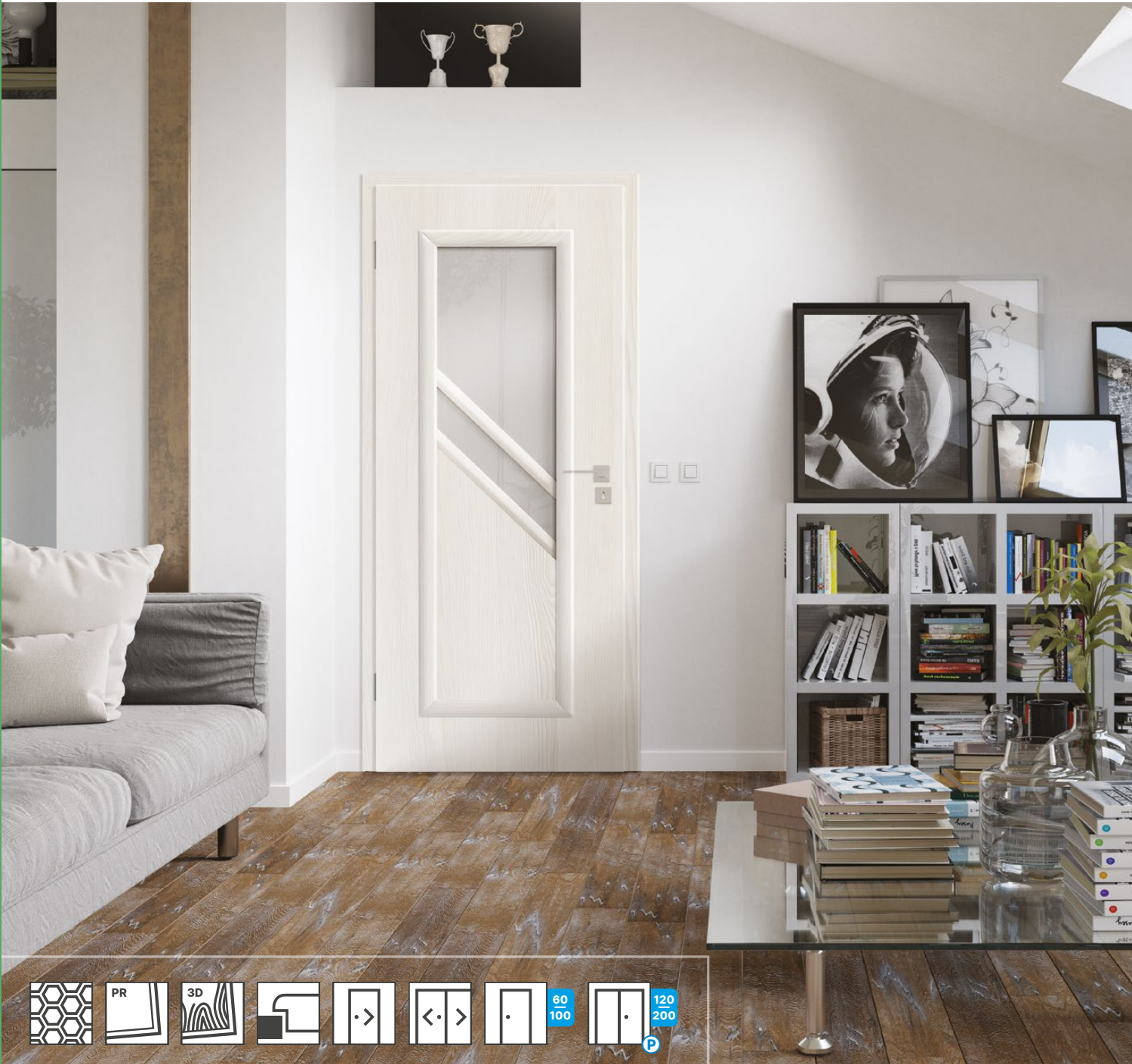

DOOR SPECIFICATION

- peripheral frame made of MDF board
- milky-white toughened safety glass

Rebated door leaf:

- two silver screw-in pintle hinges ¹
- lock: mortice key lock / bathroom lock / cylinder lock / passage lock

DEDICATED DOOR FRAMES

Hard edge R:

- fixed and adjustable door frames for rebated doors

EXTRA-COST OPTIONS

Ventilation:

- ventilation grille
- PVC ventilation sleeves

Construction:

- door leaf 100'
- third hinge
- sliding and passive door leaf ³

¹ | Door leaves 100' and reinforced door leaves regardless of the size – 3 hinges.

² | Decor is available while stocks last.

³ | Doors reinforced with perforated chipboard and passive doors are produced using peripheral frame made of softwood.



model 1



model 2



model 3

MODELS

DETAILS

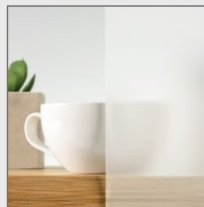

milky-white toughened safety glass



glazing frame

PRIMO

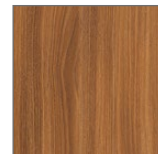

ACACIA ST



NATURAL OAK



WALNUT

3D LOOK



RIVIERA OAK



WHITE ASH

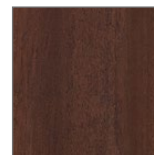

BURNT OAK ²



GRAY OAK



ANTHRACITE OAK

SIDE PANEL



PASSIVE DOOR LEAF

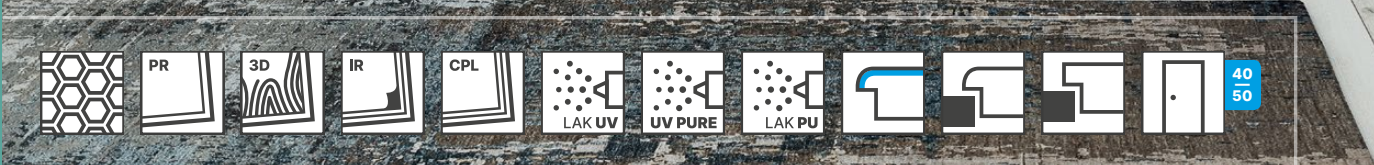

A passive door leaf, commonly known as a "side panel", is used to widen the clear opening in places where there is no need or physical possibility to install full width double leaf doors.

The active leaf is used on a daily basis, while the passive leaf remains closed. If necessary, the passive part can be quickly opened and a wider door opening can be used.

It is a very simple and useful solution that increases the functionality of your door.

DOOR SPECIFICATION

- veneer passive door leaf
- construction: peripheral frame made of MDF board
- two or three silver hinges
- adjustable strike plate and shootbolt
- available only as full version without glazing

EXTRA-COST OPTIONS

Construction:

- third hinge
- reinforced with perforated chipboard
- falling threshold

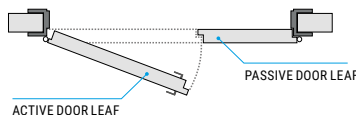



www.classen.pl

Find a door

PERFECTLY

**tailored to your needs
on our website.**

www.classen.pl



TECHNICAL PANEL DOORS

TECHNICAL PANEL DOORS

These are the doors for special tasks, and their high quality is confirmed by numerous certificates and approvals. Depending on the selected collection, they will perform different functions accordingly: they will ensure good sound insulation, fire protection or will constitute an additional protection against burglary. Moreover, their high functionality goes hand in hand with aesthetics – hence it is the ideal solution for public utility buildings, offices, hotels and restaurants.



FUNCTIONALITY OR APPEARANCE?

You do not have to choose. No more compromises. Our technical doors have it all – excellent functional qualities and aesthetically pleasing design.



FOR OFFICES,
HOTELS AND
RESTAURANTS.
Wherever
high quality,
good technical
parameters
and solid
workmanship
are important.

NATURA HK CPL / HB CPL



DOOR SPECIFICATION

- Classen Hard construction (does not apply to PN22 and PN23 versions)
- wide peripheral frame for PN22 and PN23 versions
- milky-white toughened safety glass
- possibility of shortening the leaf by 40 mm

Rebated door leaf (HK):

- two silver screwed pintle hinges ¹
- mortice key lock, bathroom lock, cylinder lock, passage lock

Non-rebated door leaf (HB):

- two openings for hinges for non-rebated door
- magnetic lock: mortice key lock / bathroom lock / cylinder lock / passage lock

DEDICATED DOOR FRAMES

HK:

- steel adjustable door frame
- steel fixed door frame
- Standard 2 pack fixed door frame (except Hamilton Oak and Cashmere decors)
- adjustable door frame

HB:

- steel fixed non-rebated door frame
- steel adjustable non-rebated door frame

EXTRA-COST OPTIONS

Ventilation:

- ventilation undercut
- ventilation undercut 15 mm (recuperation)
- PVC ventilation grille
- ventilation grille, aluminum
- steel kick-plate with ventilation grille

EXTRA-COST OPTIONS

Glazing:

- porthole 35 tr – transparent glass
- porthole 35 ml – milky-white glass
- transparent glass for the following models: 2, 3, 4, 5

Construction:

- third hinge
- perforated chipboard ²
- solid chipboard ³
- non-rebated door leaf (HB)
- door leaf 100', 110', 120'
- door leaf model PN22
- door leaf model PN23
- sliding and passive door leaf

Accessories:

- solid steel push-plate – one-sided
- solid steel push-plate – two-sided
- solid steel kick-plate – one-sided
- solid steel kick-plate – two-sided
- falling threshold

¹ Door leaves 100' and reinforced door leaves regardless of the size – 3 hinges.

² Maximum leaf width 110, without Hard reinforcement.

³ Maximum leaf width 100, without Hard reinforcement.

⁴ Models PN22 and PN23 available only as 1-leaf, width 60'-100'. They are not available in a non-rebated version and are not available with the following frames: Adjustable 80, Standard 2-pack fixed and steel door frame.

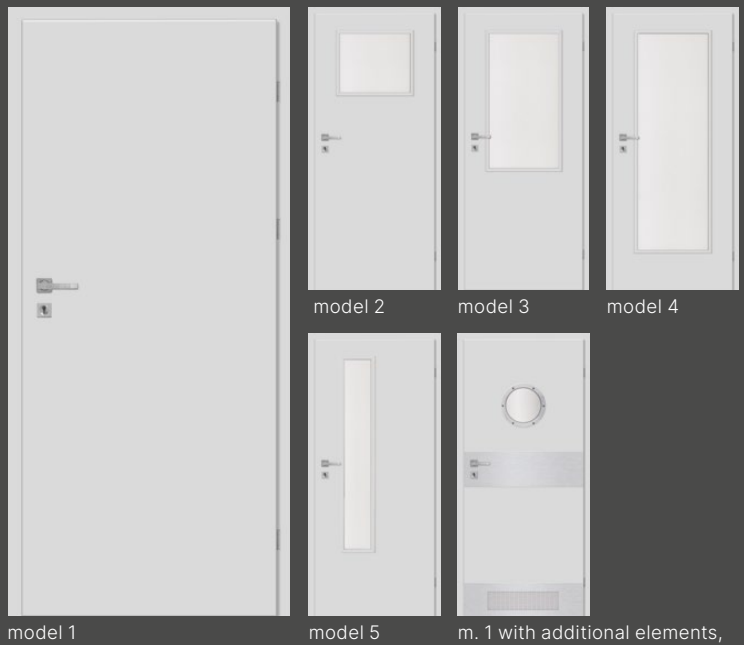

MODELS

DETAILS

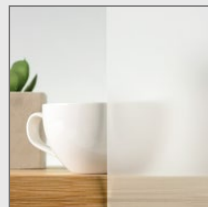

milky-white toughened safety glass



glazing frame

m. 1 with additional elements, more information on page 150.

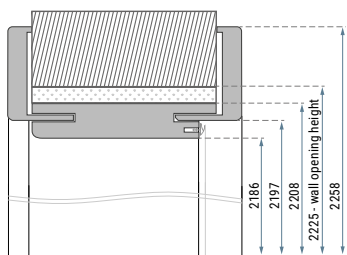

Dimensions of door frame for PN22 door.

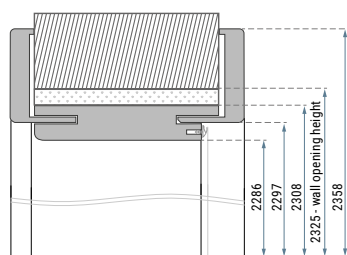

Dimensions of door frame for PN23 door.

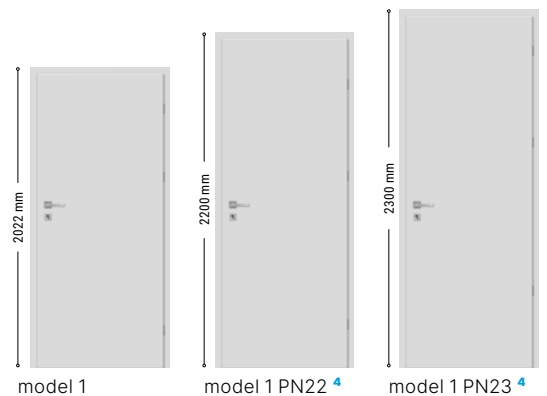

IRIDIUM



MARONE OAK



UNI BLACK

CPL



CASHMERE

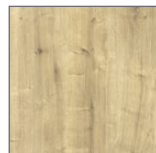

HAMILTON OAK VERTICAL



HAMILTON OAK HORIZONTAL

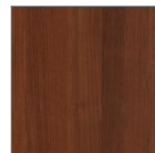

ITALIAN WALNUT



LIGHT ACACIA

CPL



NORWEGIAN ASH



GRIGIO OAK

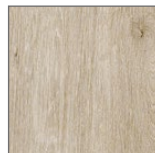

KENDAL OAK



WHITE WITH HORIZONTAL STRUCTURE



WHITE RAL 9003



GRAY RAL 7047



GRAPHITE RAL 7024

NATURA HK HPL / HB HPL

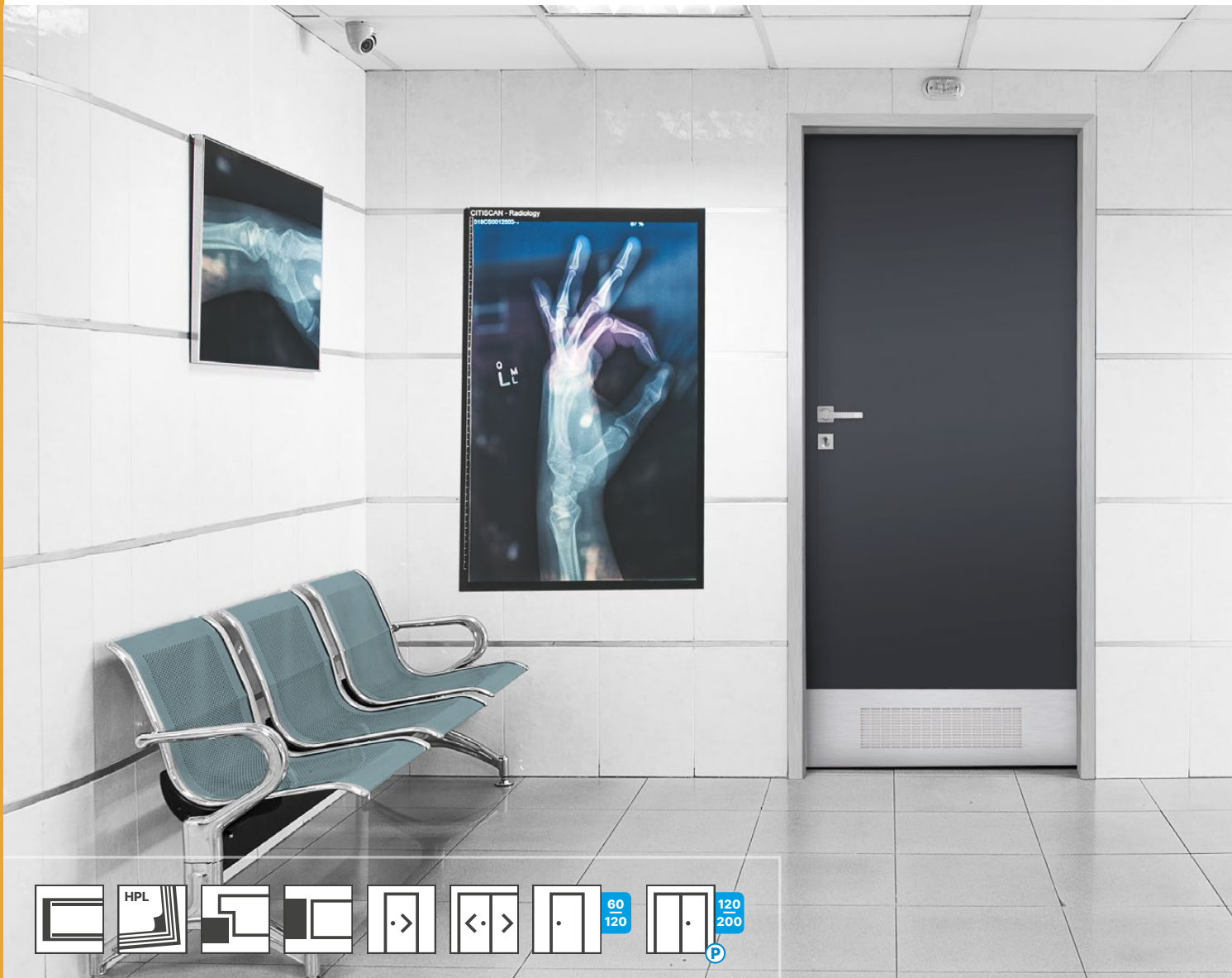

DOOR SPECIFICATION

- Classen Hard construction
- milky-white toughened safety glass
- possibility of shortening the leaf by 40 mm

Rebated door leaf (HK):

- two silver screw-in pintle hinges ¹
- lock: mortice key lock / bathroom lock / cylinder lock / passage lock

Non-rebated door leaf (HB):

- two openings for hinges for non-rebated door
- magnetic lock: mortice key lock / bathroom lock / cylinder lock / passage lock

¹ Door leaves 100' and reinforced door leaves regardless of the size – a 3 hinges.

² Maximum leaf width 110, without Hard reinforcement.

³ Maximum leaf width 100, without Hard reinforcement.

DEDICATED DOOR FRAMES

HK:

- steel adjustable door frame
- steel fixed door frame

HB:

- adjustable non-rebated door frame
- steel fixed non-rebated door frame
- steel adjustable non-rebated door frame

EXTRA-COST OPTIONS

Ventilation:

- ventilation undercut
- ventilation undercut 15 mm (recuperation)
- PVC ventilation grille
- ventilation grille, aluminum
- steel kick-plate with ventilation grille

Glazing:

- porthole 35 tr – transparent glass
- porthole 35 ml – milky-white glass
- transparent glass for the following models: 2, 3, 4, 5

EXTRA-COST OPTIONS

Construction:

- third hinge
- perforated chipboard ²
- solid chipboard ³
- non-rebated door leaf (HB)
- door leaf 100', 110', 120'
- sliding and passive door leaf

Accessories:

- solid steel push-plate – one-sided
- solid steel push-plate – two-sided
- solid steel kick-plate – one-sided
- solid steel kick-plate – two-sided
- falling threshold

ADDITIONAL INFORMATION

- other HPL decors (page 166) available upon individual enquiries: inwestycje@classen.com.pl
- decors not included in the standard offer are available with a rebate in brushed aluminum colour



model 1

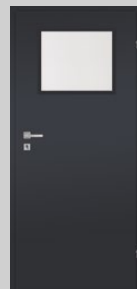

model 2

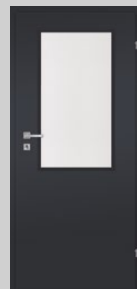

model 3



model 4



model 5

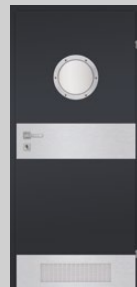

m. 1 with additional elements,
more information on page 150.

MODELS

DETAILS



milky-white toughened
safety glass



glazing frame

HPL



WHITE RAL 9003



GRAY RAL 7047



GRAPHITE
RAL 7024

GUARD



DOOR SPECIFICATION

- reinforced construction plus, door leaf thickness – 40 mm
- door leaf edge protected with stainless steel kick-plate
- glazing frame made of stainless steel
- milky-white toughened safety glass, thickness: 4 mm
- three reinforced three-wing silver hinges
- cylinder lock
- reinforcement for door closer
- doors sold as a set with door frame

DEDICATED DOOR FRAMES

Hard edge K:

- Guard steel fixed and adjustable door frame

EXTRA-COST OPTIONS

Ventilation:

- PVC ventilation grille
- ventilation grille, aluminum
- steel kick-plate with ventilation grille

Construction:

- door leaf 100'
- door leaf 110'

EXTRA-COST OPTIONS

Accessories:

- solid steel push-plate – one-sided
- solid steel push-plate – two-sided
- solid steel kick-plate – one-sided
- solid steel kick-plate – two-sided

ADDITIONAL INFORMATION

- other HPL decors (page 166) available upon individual enquiries: inwestycje@classen.com.pl
- decors not included in the standard offer are available with a rebate in brushed aluminum colour
- additional information: possibility of executing custom door leaves, door frames and glasses upon individual requests: inwestycje@classen.com.pl

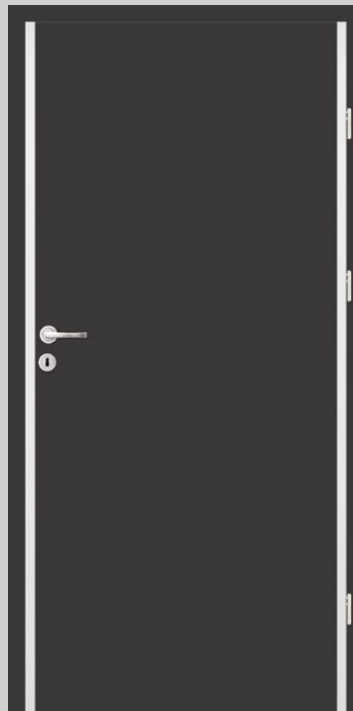

model 1



model 2



model 3



model 4



model 5

MODELS

DETAILS



three-wing hinge



rebate with stainless steel profile

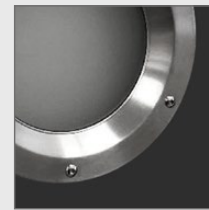

porthole

CPL



CASHMERE



HAMILTON OAK VERTICAL



HAMILTON OAK HORIZONTAL

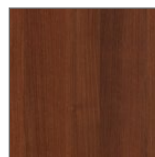

ITALIAN WALNUT



LIGHT ACACIA



NORWEGIAN ASH

CPL



GRIGIO OAK



KENDAL OAK



WHITE WITH HORIZONTAL STRUCTURE



WHITE RAL 9003



GRAY RAL 7047



GRAPHITE RAL 7024

HPL

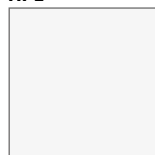

WHITE RAL 9003



GRAY RAL 7047



GRAPHITE RAL 7024

BORD

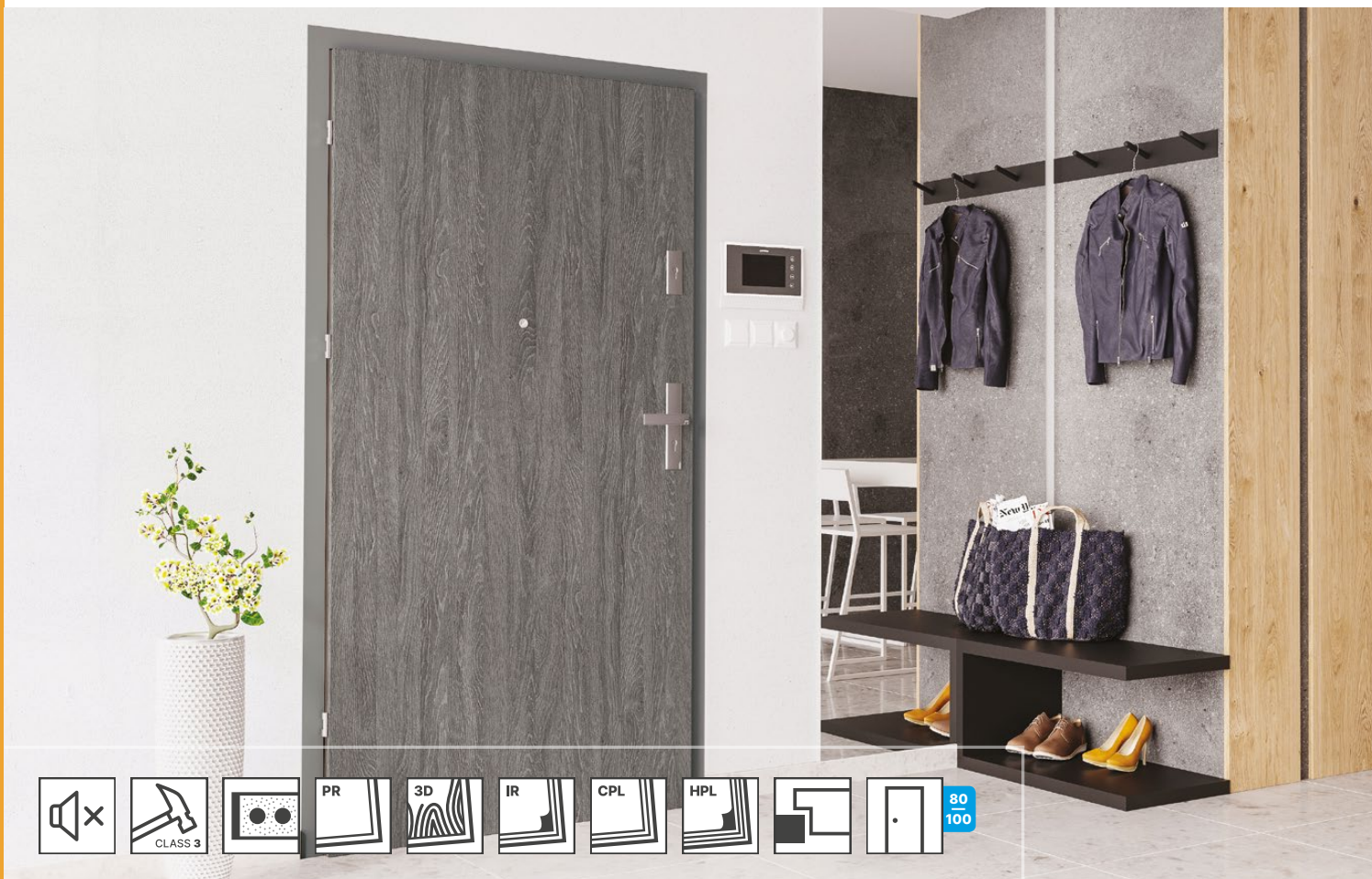

BORD internal entrance door is designed for use in residential housing, public utility and collective residential buildings.

DOOR SPECIFICATION

- acoustic resistance - 32 dB for B46 W2 and W46 W2 door
 - if BORD MDF fixed door frame is used
 - if BORD steel fixed door frame is used
- three silver adjustable double-pin screw-in pintle hinges
- leaves thickness:
 - B40 – 40 mm, B46 and W46 – 46 mm

DEDICATED DOOR FRAMES

- BORD MDF fixed (except Cashmere, Hamilton Oak)
- BORD steel fixed
- BORD steel corner
- HYBRYDA (except Cashmere, Hamilton Oak)

EXTRA-COST OPTIONS

Finish:

- HPL laminates

Construction:

- door leaf and door frame 100'

Accessories:

- peephole
- falling threshold
- steel push-plate with room number
 - one-sided

ADDITIONAL INFORMATION

- spacing of holes in the lock:
 - lower deadbolt lock – 90 mm (B)
 - multipoint lock – 72 mm (W)
- cylinder locks and door handles do not constitute door leaf equipment
- cylinder lock size:
 - B40 – 26/36, B46 and W46 – 26/40
- technical approval: AT – 15-8467/2016
- possibility of executing custom doors and door frames upon individual requests: inwestycje@classen.com.pl
- other HPL decors available upon individual enquiries: inwestycje@classen.com.pl
- decors not included in the standard offer are available with a rebate in brushed aluminum colour

	B40 W1	B46 W1	B46 W2	W46 W1	W46 W2
reinforced peripheral frame made of softwood	✓	✓	✓	✓	✓
steel flat bars		✓	✓	✓	✓
perforated chipboard	✓	✓	✓	✓	✓
two deadbolt locks for cylinder lock	✓	✓	✓		
multipoint lock for cylinder lock				✓	✓
falling threshold and three interlocking door bolts			✓		✓

¹ | Decor is available while stocks last.



model 1



vertical steel push-plate
with room number (option)

MODELS

DETAILS



bottom deadbolt lock



top deadbolt lock

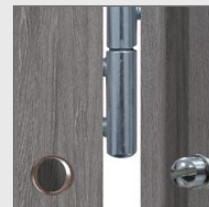

interlocking door bolt



falling threshold

PRIMO

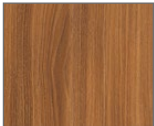

ACACIA ST



BEECH



NATURAL OAK



WALNUT

3D LOOK

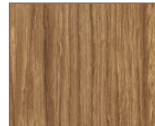

HONEY CATANIA



GESSATO OAK



CLEVELAND OAK



RIVIERA OAK

3D LOOK



RIVIERA OAK



WHITE ASH



COLOMBIA LIGHT
WALNUT



OILED OAK



BURNT OAK 1



GRAY OAK



ANTHRACITE OAK



GRAPHITE ASH

IRIDIUM

IRIDIUM

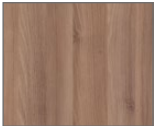

BROWN ASH



SNOW ASH 1



MARONE OAK



WENGE

CPL

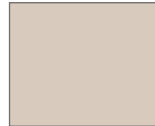

CASHMERE



HAMILTON OAK
VERTICAL



HAMILTON OAK
HORIZONTAL



ITALIAN WALNUT

CPL



LIGHT ACACIA



NORWEGIAN ASH



GRIGIO OAK



KENDAL OAK



WHITE WITH
HORIZONTAL
STRUCTURE



WHITE RAL 9003



GRAY RAL 7047



GRAPHITE
RAL 7024



WHITE RAL 9003



GRAY RAL 7047



GRAPHITE
RAL 7024

HPL

BORD W3

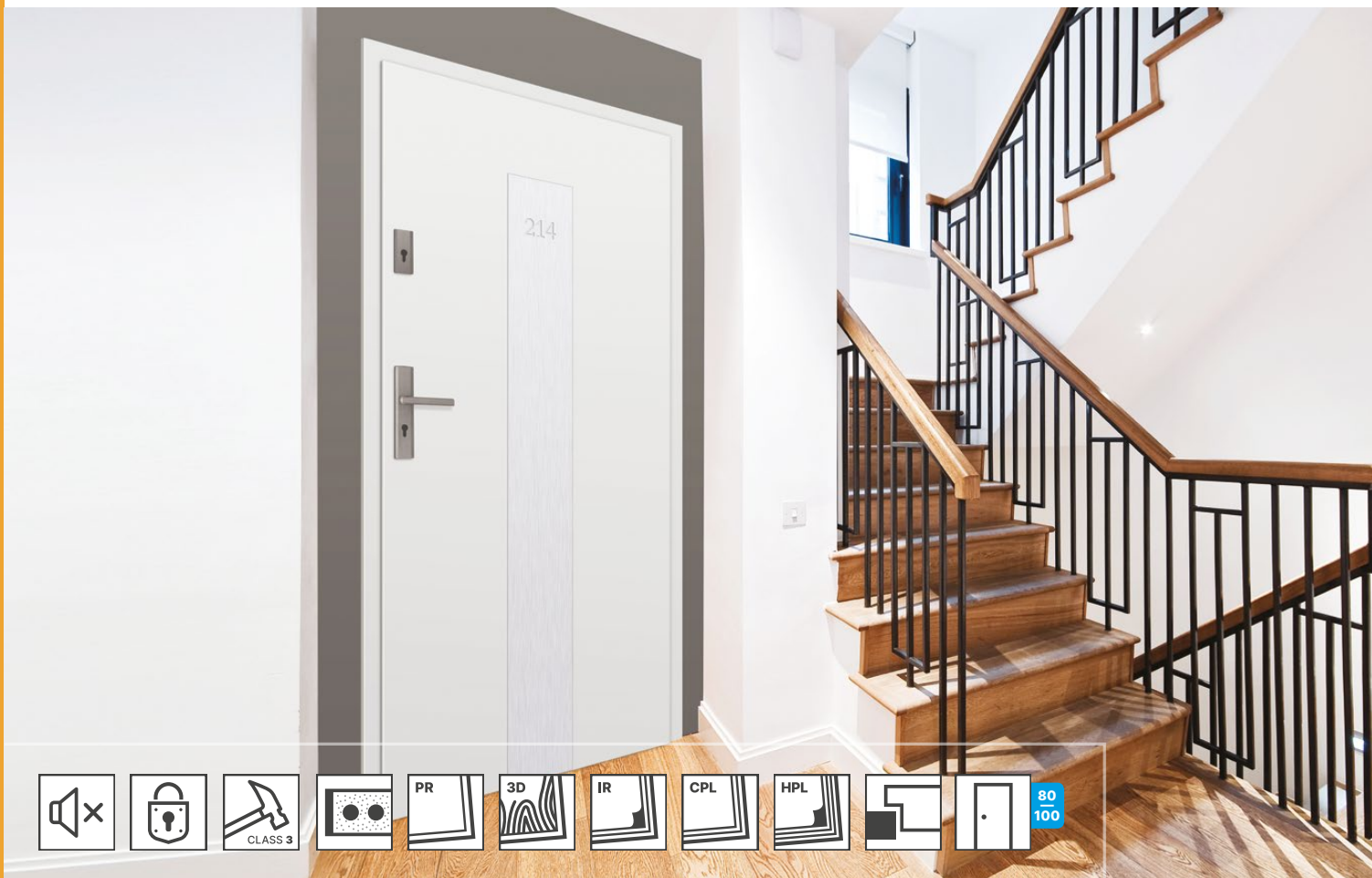

BORD W3 internal entrance door meet the requirements of the RC2 anti-burglary protection class, provided that the door is installed with a dedicated steel door frame (page 142), handle with escutcheon (page 159) and a set of cylinder locks fulfilling the second anti-burglary class (page 154).

Construction of a door leaf with thickness of 46 mm: peripheral frame made of softwood reinforced with special steel flat bar and a plywood. A perforated chipboard was used as a core. All is covered with wood-based board, veneered with Classen decors.

DOOR SPECIFICATION

- three anti-burglary three-way silver hinges
- Multistrong multi-point strip lock
- multipoint lock for cylinder lock (openings spacing 72 mm)
- leaf thickness: 46 mm
- door leaf available only with BORD W3 steel fixed door frame – (page 142)

DEDICATED DOOR FRAMES

- BORD W3 STEEL FIXED

EXTRA-COST OPTIONS

Construction:

- door leaf and door frame 100'

Accessories:

- peephole
- transition threshold
- falling threshold
- steel push-plate with room number – one-sided

ADDITIONAL INFORMATION

- other HPL decors available upon individual enquiries: inwestycje@classen.com.pl
- decors not included in the standard offer are available with a rebate in brushed aluminum colour

¹ | Decor is available while stocks last.



model 1



vertical steel push-plate
with room number (option)

MODELS

DETAILS

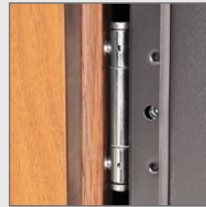

three-wing hinge

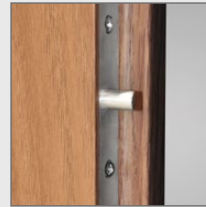

interlocking door
bolts strip



multipoint lock

PRIMO



ACACIA ST



BEECH



NATURAL OAK



WALNUT

3D LOOK

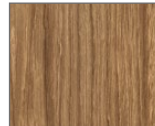

HONEY CATANIA



GESSATO OAK



CLEVELAND OAK



SONOMA OAK

3D LOOK

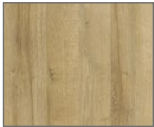

RIVIERA OAK



WHITE ASH



COLOMBIA LIGHT
WALNUT

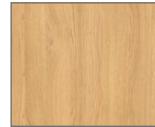

OILED OAK



BURNT OAK¹



GRAY OAK



ANTHRACITE OAK

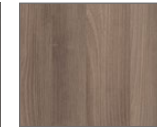

GRAPHITE ASH

IRIDIUM

IRIDIUM

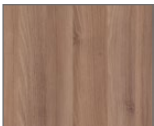

BROWN ASH



SNOW ASH¹



MARONE OAK



WENGE

CPL

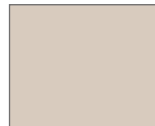

CASHMERE



HAMILTON OAK
VERTICAL



HAMILTON OAK
HORIZONTAL

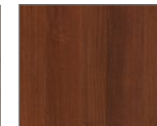

ITALIAN WALNUT

CPL



LIGHT ACACIA



NORWEGIAN ASH



GRIGIO OAK



KENDAL OAK



WHITE RAL 9003



GRAY RAL 7047



GRAPHITE
RAL 7024

HPL



WHITE RAL 9003



GRAY RAL 7047



GRAPHITE
RAL 7024

FIRE DOORS - EI30 / EI60

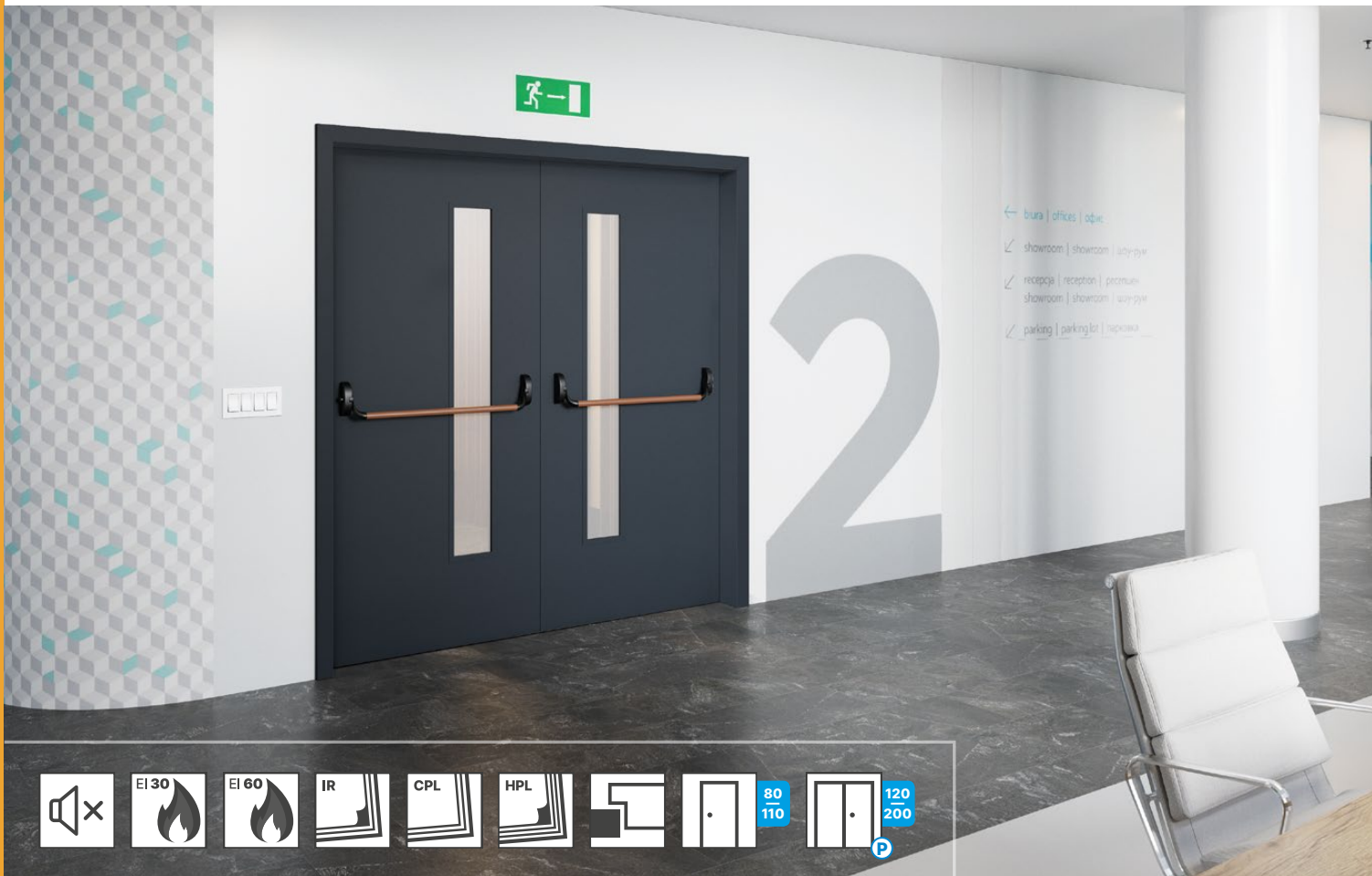

Internal entrance fire door is designed for use in residential housing, public utility and collective residential buildings as the door fulfilling the requirements for EI30 or EI60 fire resistance class, S_a and S_m smoke resistance class and acoustic resistance up to 32 dB.

DOOR SPECIFICATION

- special two-layer board / peripheral frame made of softwood
- mortise latch lock for cylinder lock with insulation insert
- falling threshold – W2 version
- Hard Edge K door edge profile
- surface finish with Classen laminate: Iridium, CPL, HPL
- expanding seal in door leaf rebate
- four silver pintle hinges
- single leaf - acoustic resistance, version W2: 32 dB
- double leaf - acoustic resistance, version W2: 27 dB for EI30, 32 dB for EI60
- leaf thickness: EI30 – 50 mm, EI60 – 60 mm
- in glazed version: transparent glass with higher fire proof class
- openings spacing in the lock 72 mm
- EI 60 door leaf available with steel fixed door frame
- doors sold as a set with door frame

DEDICATED DOOR FRAMES

- FIRE wooden fixed door frame
- FIRE steel fixed door frame

EXTRA-COST OPTIONS

Finish:

- HPL laminate

Construction:

- door leaf and door frame 100'
- door leaf and door frame 101'
- door leaf and door frame 110'

Accessories:

- steel threshold
- falling threshold
- solid steel push-plate – one-sided
- solid steel push-plate – two-sided
- solid steel kick-plate – one-sided
- solid steel kick-plate – two-sided

ADDITIONAL INFORMATION

- **version W1** – does not have S_a , S_m smoke-proof class and acoustic resistance (falling threshold)
- national technical approval: ITB-KOT-2018/0407 1st edition
- certificates of conformity: ITB Nr 020-UWB-2697/W
- in order to fulfill KOT requirements, fire door must be purchased together with a door-closer
- internal entrance doors only in full version
- cylinder locks and door handles do not constitute door leaf equipment
- cylinder locks size: EI 30 - 36x36; EI 60 – 36x46 (for handle escutcheons with a thickness of approx. 10 mm)
- size 91 and 101 meets the technical requirements for light opening width
- possibility to execute custom width and height of single and double door leaves upon individual enquiry: inwestycje@classen.com.pl

¹ Decor is available while stocks last.

² HPL decors: door frames for HPL decors available in Iridium or CPL veneer. Colour differences regarding the shade are permissible. Other HPL decor (page 166) available upon individual enquiries: inwestycje@classen.com.pl. (Decors outside the standard range are offered with the rebate in brushed aluminum colour.)



m. 1 – EI30/EI60



m. 2 – EI30/EI60



m. 3 – EI30



m. 3 – EI60



m. 2 with steel kick-plate



m. 1 with steel push-plate with room number

MODELS

DETAILS



falling threshold



pinthole hinge of rebated door with 3D regulation



DC 135 door closer with slide rail



DC140 surface-mounted door closer with standard arm

IRIDIUM

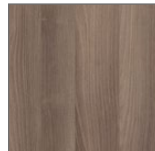

GRAPHITE ASH

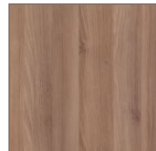

BROWN ASH



SNOW ASH ¹



MARONE OAK



WENGE

CPL



ITALIAN WALNUT



LIGHT ACACIA



NORWEGIAN ASH



GRIGIO OAK



KENDAL OAK

CPL



WHITE WITH HORIZONTAL STRUCTURE



WHITE RAL 9003



GRAY RAL 7047



GRAPHITE RAL 7024

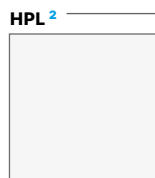

WHITE RAL 9003



GRAY RAL 7047

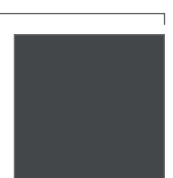

GRAPHITE RAL 7024

HPL ²

ACOUSTIC DOORS – EI30 / 42 dB



EI30 / 42 dB FIRE DOORS

DOOR SPECIFICATION

- construction: peripheral frame made of softwood with specialized board core, all covered with HDF board
- cylinder lock, spacing 72 mm
- single leaf 70'-90'
- falling threshold
- expanding seals
- mechanical resistance class 3 (acc. to PN-EN 1192:2001)

K rebated door leaf: ¹

- 4 pintle hinges
- additional seal in the rebate
- dedicated door frame: Fixed MDF 42db

B non-rebated door leaf: ¹

- 4 hidden hinges
- dedicated door frame: Fixed non-rebated MDF 42dB

42 dB ACOUSTIC DOORS

DOOR SPECIFICATION

- construction: peripheral frame made of softwood with specialized board core, all covered with MDF board
- cylinder lock, spacing 72 mm
- single leaf 60'-90'
- falling threshold
- mechanical resistance class 3 (acc. to PN-EN 1192:2001)

K rebated door leaf: ¹

- 4 pintle hinges
- additional seal in the rebate
- dedicated door frame: Fixed MDF 42db

B non-rebated door leaf: ¹

- 4 hidden hinges
- dedicated door frame: Fixed non-rebated MDF 42dB

ADDITIONAL INFORMATION

- national technical approval: ITB-KOT-2019/1154, 1st edition
- door can be used as entrance door
- in order to fulfill KOT requirements, fire door must be installed together with a door-closer
- cylinder locks size: 36/46 for rebated and non-rebated doors (for handle escutcheons with a thickness of approx. 10 mm)
- other HPL decors available upon individual enquiries: inwestycje@classen.com.pl
- decors not included in the standard offer are available with a rebate in brushed aluminum colour

EXTRA-COST OPTIONS

Finish:

- Venom Alu

Accessories:

- solid steel push-plate – one-sided
- solid steel push-plate – two-sided
- solid steel kick-plate – one-sided
- solid steel kick-plate – two-sided

¹ Acoustic resistance: rebated: $R_w(C;Ctr)=44 (-2;-6)$ dB / non-rebated: $R_w(C;Ctr)=44 (-2;-5)$ dB

² HPL decors: door frames for HPL decors available in Iridium or CPL veneer. Colour differences regarding the shade are permissible.

³ Decor is available while stocks last.

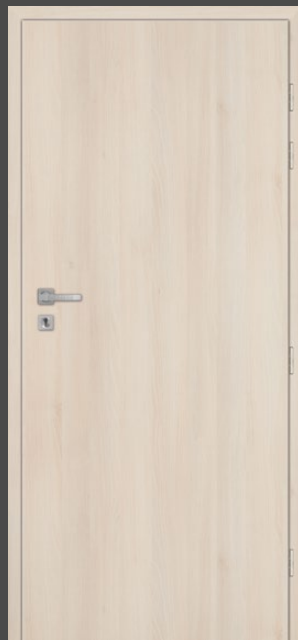

rebated fire door
EI30 42 dB / rebated - 42 dB

MODELS

DETAILS



rebated door rebate profile



non-rebated door rebate profile



rebated door lock



non-rebated door lock

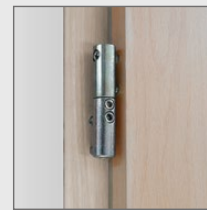

rebated door 3D pintle hinge



non-rebated door hidden hinge



falling threshold



DC 840 covered door closer with slide rail (non-rebated door)



DC 135 door closer with slide rail (rebated door)

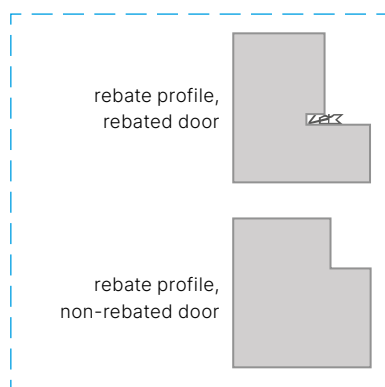

IRIDIUM

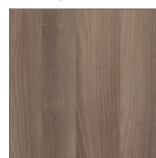

GRAPHITE ASH

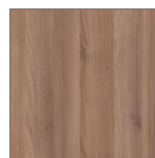

BROWN ASH



SNOW ASH ³



MARONE OAK



WENGE

CPL

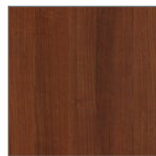

ITALIAN WALNUT



LIGHT ACACIA



NORWEGIAN ASH



GRIGIO OAK

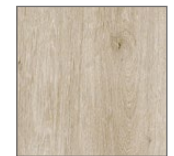

KENDAL OAK

CPL



WHITE RAL 9003



GRAY RAL 7047



GRAPHITE RAL 7024

HPL ²



WHITE RAL 9003



GRAY RAL 7047



GRAPHITE RAL 7024

VENOM

TECHNICAL PANEL DOORS MILLING



OPTIONAL MILLING PATTERNS AVAILABLE FOR BORD AND FIRE DOOR COLLECTIONS

NOTE

- Available as an extra-cost option for full models from the BORD, BORD W3 and FIRE door collections.



¹ | Decor is available while stocks last.



model 3

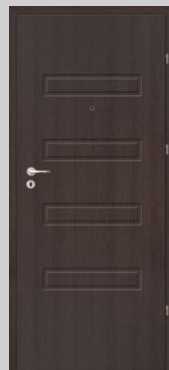

model 6

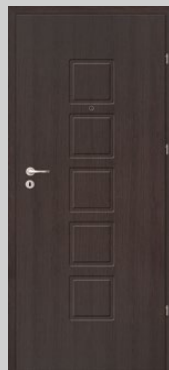

model 7

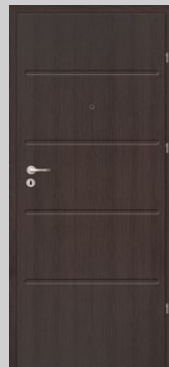

model 8



model 9



model 10



model 11

MODELS

PRIMO

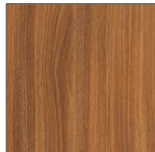

ACACIA ST

3D LOOK



COLOMBIA LIGHT
WALNUT

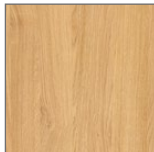

OILED OAK

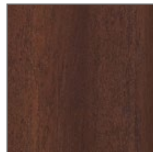

BURNT OAK¹

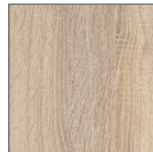

SONOMA OAK



WENGE

IRIDIUM

VENOM ALU



OPTIONAL ALUMINUM INSERT FINISHES FOR THE BORD, BORD W3, FIRE, NATURA HK/HB CPL AND HPL AS WELL AS NATURA HR COLLECTIONS

NOTE

- Available as an extra-cost option for full models from the BORD, BORD W3, FIRE, Natura HK/HB CPL, Natura HK/HB HPL and Natura HR door collections (in selected decors, with construction reinforced with perforated chipboard). Aluminium profile, width: 8 mm (colour – stainless steel / INOX), aligned with a door leaf surface.

¹ | Decor is available while stocks last.

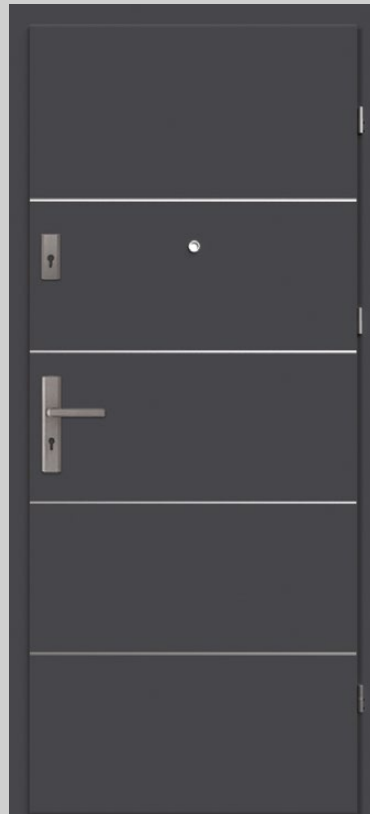

model 1



model 3



model 4



model 5



model 6

MODELS



aluminium profile 8 mm

DETAILS

IRIDIUM

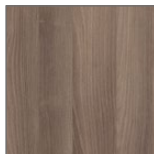

GRAPHITE ASH

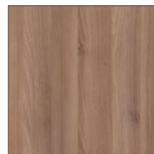

BROWN ASH



SNOW ASH ¹



ITALIAN WALNUT



LIGHT ACACIA



NORWEGIAN ASH



GRIGIO OAK

CPL

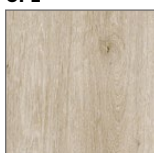

KENDAL OAK



WHITE RAL 9003



GRAY RAL 7047



GRAPHITE
RAL 7024



WHITE RAL 9003



GRAY RAL 7047



GRAPHITE
RAL 7024

HPL

ACOUSTIC DOORS



FULL: 27 dB – Rw (27–30)

DOOR SPECIFICATION

- peripheral frame made of softwood, covered with HDF board
- 3 silver screw-in pintle hinges
- lock: mortice key lock / bathroom lock / cylinder lock / passage lock
- falling threshold

DEDICATED DOOR FRAME

- Adjustable door frame
Rw (C; Ctr)= 30(-1; -1) dB

FULL: 32 dB – Rw (32–34)

DOOR SPECIFICATION

- specialized board, peripheral frame made of softwood, covered with HDF board
- 3 silver screw-in pintle hinges
- lock: mortice key lock / bathroom lock / cylinder lock / passage lock
- falling threshold

DEDICATED DOOR FRAME

- Adjustable door frame
Rw (C; Ctr)= 34 (-1; -2) dB
- Steel fixed door frame
Rw (C; Ctr)= 32 (0;-1) dB

WITH GLAZING: 32 dB – Rw (32–33)

DOOR SPECIFICATION

- safe transparent glass
- specialized board, peripheral frame made of softwood, covered with HDF board
- 3 silver screw-in pintle hinges
- lock: mortice key lock / bathroom lock / cylinder lock / passage lock
- falling threshold

DEDICATED DOOR FRAME

- Adjustable door frame
Rw (C; Ctr)= 32 (0;-2) dB
- Steel fixed door frame
Rw (C; Ctr)= 33 (0;-2) dB



model 1 – 27 dB



model 1 – 32 dB



model 2 – 32 dB



model 3 – 32 dB

MODELS

ADDITIONAL INFORMATION

- acoustic resistance 27 dB (27–30 dB).
Report from GLA-1144.3/13.
- acoustic resistance 32 dB (32–34 dB).
Report from GLA-1166.2/14.a.

EXTRA-COST OPTIONS

- **Construction:**
- door leaf 100'



Classen acoustic doors are available in all decors from the following groups: Primo, 3D Look, Iridium, CPL, HPL, lacquered except for white matt (details on page 160) and optionally in RAL palette colours.



DOORS ALIGNED WITH THE WALL

DOORS ALIGNED WITH THE WALL

This is the perfect choice for those looking for original solutions. No frames, hidden door frame and hinges, and a door leaf make this door perfectly blend with the wall. Thanks to this your room will turn into a mysterious casket, where the presence of the door can only be revealed by a discreet outline of the handle. Or maybe you want to experiment in a completely different style? This type of door may as well be distinguished by the original colour, bringing to mind an abstract painting filling the wall.



COMPACT

DOORS ALIGNED WITH THE WALL

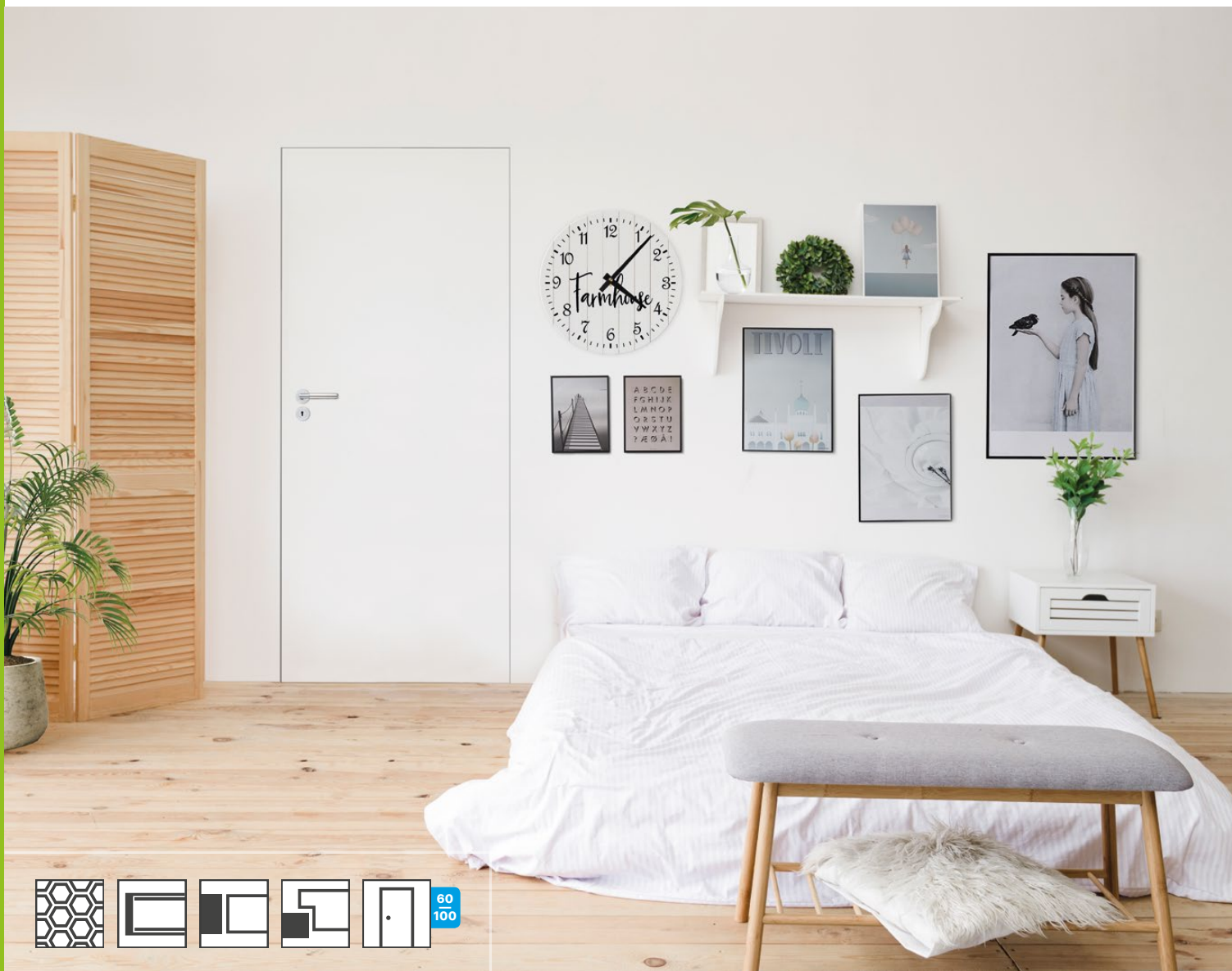

The Compact system consists of interior door leaf, veneered or for self-finishing and an aluminum door frame. After installation, the entire system forms a uniform surface with the wall.

DOOR SPECIFICATION

- panel door leaf, solid, thickness: 40 mm
- external door leaf - non-rebated, opening outwards (height 2022 mm)
- internal door leaf - rebated, opening inwards (height 2032 mm)
- surface finishing: primer (surface prepared for self-finishing - painting *), 3D Look and Iridium veneers, CPL and HPL laminates
- two openings for hidden hinges, adjustable (3 hinges for the width of 100' and height from 2222 to 2332 mm)
- magnetic lock: mortice key lock / bathroom lock / cylinder lock / passage lock

EXTRA-COST OPTIONS

Ventilation:

- ventilation undercut
- ventilation undercut 15 mm (recuperation)

Construction:

- perforated chipboard
- door leaf 100'
- door leaf height 2132, 2122 mm
- door leaf height 2232, 2222 mm
- door leaf height 2332, 2322 mm

Extra-cost for width and height apply to door leaf and door frame.

Accessories:

- falling threshold

DEDICATED DOOR FRAMES

Aluminum door frame:

- The frame is available in an external and internal version, raw, with the possibility of self-painting after impregnation.
- The package includes: 2 or 3 hinges, gaskets, impregnating agent, installation instruction and accessories needed for its installation.
- Installation of the frame on a raw wall requires application of plaster or drywall.

* | Tests conducted using original wall paints available on the market.

INTERNAL DOOR FRAME

DOOR LEAF HEIGHT H_d	MOUNTING OPENING HEIGHT H_o	DOOR LEAF EXTER- NAL HEIGHT H_z	CLEAR OPENING HEIGHT H_p	NUMBER OF HINGES
2032	2081	2074	2032	2
2132	2181	2174	2132	2
2232	2281	2274	2232	3
2332	2381	2374	2332	3

DOOR LEAF WIDTH S_d	MOUNTING OPENING WIDTH S_o	DOOR LEAF EXTER- NAL WIDTH S_z	DOOR LEAF CLEAR OPENING WIDTH S_p
618	698	688	603
718	798	788	703
818	898	888	803
918	998	988	903
1018	1098	1088	1003

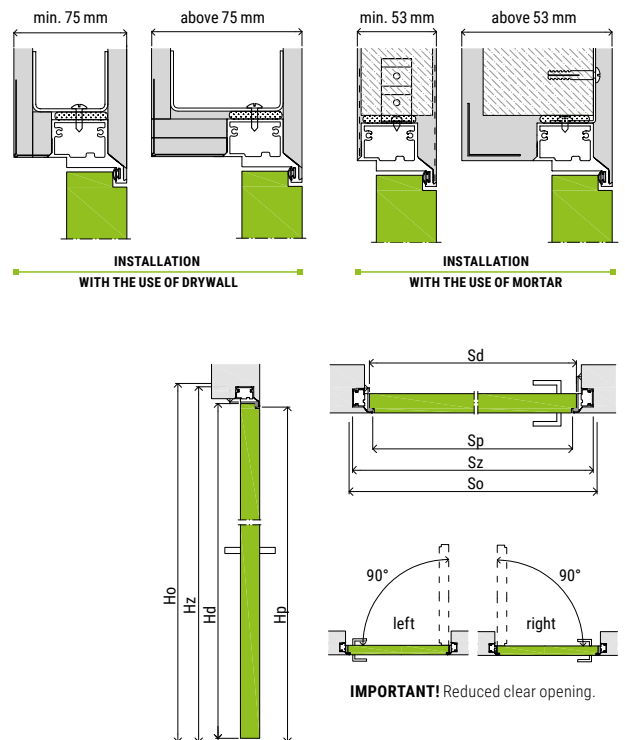

EXTERNAL DOOR LEAF

DOOR LEAF HEIGHT H_d	MOUNTING OPE- NING HEIGHT H_o	DOOR LEAF EXTER- NAL HEIGHT H_z	CLEAR OPENING HEIGHT H_p	NUMBER OF HINGES
2022	2071	2064	2022	2
2122	2171	2164	2122	2
2222	2271	2264	2222	3
2322	2371	2364	2322	3

DOOR LEAF WIDTH S_d	MOUNTING OPE- NING WIDTH S_o	DOOR LEAF EXTER- NAL WIDTH S_z	DOOR LEAF CLEAR OPE- NING WIDTH S_p
618	698	688	603
718	798	788	703
818	898	888	803
918	998	988	903
1018	1098	1088	1003

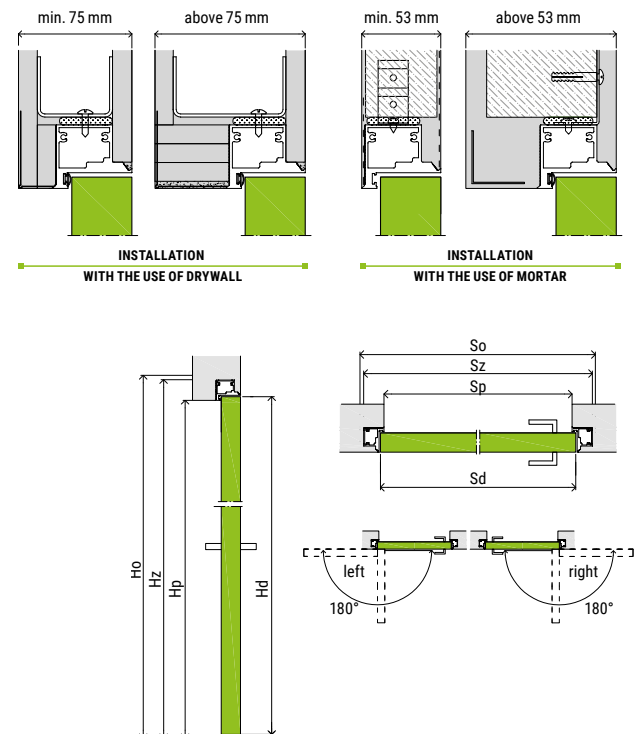

Classen doors in the Compact system are available in all decors from the following groups: Primo, 3D Look, Iridium, CPL, HPL, lacquered (details on page 160–163). HPL decors – only standard offer.

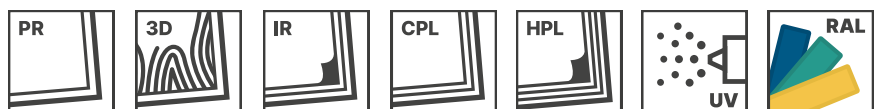



SLIDING DOOR SYSTEMS

SLIDING DOOR SYSTEMS

A way to create an original entrance to the room. They ensure comfortable use and freedom of movement. They are perfect for small spaces, where using traditional doors is a really hard task. They also do a great job on a larger surface, catching the eye and giving the interior a modern, dynamic character. They are available in single and double leaf versions. They also differ depending on the installation method - they can be retracted into the wall or intended for on-wall mounting. Leaves can be chosen from many models with different aesthetics, which is why everyone will find an option ideally suited to their interior.



DO YOU WANT TO SAVE SOME SPACE IN THE FLAT?

Sliding doors will help you with that. Thanks to the convenient way of opening and closing, they do not use additional space. Especially recommended for interiors where every centimeter is important.

NON-OBVIOUS DECORATION.

The door can play the first fiddle in interior design. Especially double leaf models that look very impressive. In spacious rooms they will hit the bullseye.



ON-WALL SLIDING DOOR SYSTEM



DOUBLE LEAF SLIDING DOOR SYSTEM

SINGLE LEAF SLIDING DOOR SYSTEM

- Single leaf on-wall sliding door system consists of a sliding mechanism, masking element (including a bumper beam) and door leaf. Each element must be purchased separately.
- As a standard, the system is installed directly on the wall, optionally it can be installed with a tunnel frame which must be purchased separately. Wall opening height for installation with tunnel: 2060 mm, for assembly without tunnel: 2022 mm.
- Single leaf mechanism is equipped with a 2.5 m long rail, which should be cut to the final size.
- Single leaf sliding door system is offered in the following dimensions: 60', 70', 80', 90', 100'.

DOUBLE LEAF SLIDING DOOR SYSTEM

- Double leaf on-wall sliding door system consists of a sliding mechanism, masking element and door leaf. Each element must be purchased separately.
- Double leaf on-wall sliding system is opened synchronously, i.e. by sliding one leaf, both door leaves open at the same time. Synchronous system requires ordering two door leaves of the same width.
- Double leaf mechanism is equipped with two 2.5 m long rails and masking elements, which should be cut to the final size. Wall opening height for installation with tunnel: 2060 mm, for assembly without tunnel: 2022 mm.

- As a standard, the system is installed directly on the wall, optionally it can be installed with a tunnel frame which must be purchased separately.
- Double leaf sliding system is offered in the following dimensions: 120', 140', 160', 180', 200' (for doors opening synchronously).
- Door leaves for the sliding door system are manufactured in non-rebated version in the external dimensions of rebated door, e.g.: 844 x 2035 mm (80').

AVAILABILITY

- Sliding door system is available in all decors and collections apart from the following collections: Classic, Andromeda, Salvano.

EXTRA-COST OPTIONS



door closer



hook lock (mortice key lock, bathroom lock)



SINGLE LEAF SLIDING DOOR SYSTEM

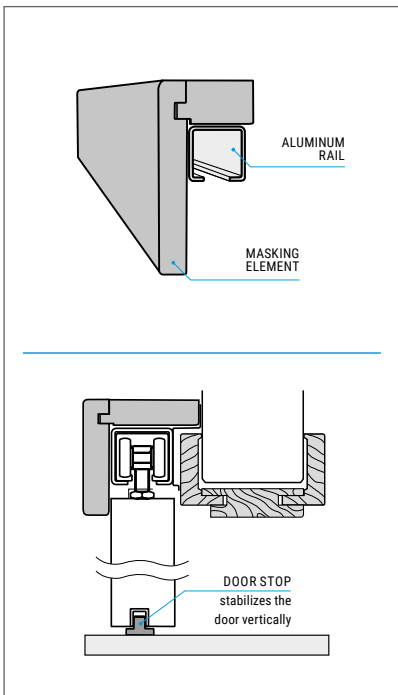

VERTICAL CROSS-SECTION OF THE SLIDING SYSTEM

PULL HANDLES INSTALLED IN SLIDING DOORS AS AN EXTRA-COST OPTION.

THE COLOUR OF THE PULL HANDLE ASSIGNED TO A GIVEN DECOR.

PCV PULL HANDLES



Primo: White
3D Look: White Ash
Iridium: UNI White
CPL: White RAL 9003, White with horizontal structure
Lacquered



3D Look: Colombia Light Walnut, Gray Oak, Anthracite Oak
Iridium: Graphite Ash, Gray Matt, Wenge, UNI Black
CPL: Light Acacia, Gray RAL 7047, Graphite RAL 7024, Grigio Oak, Kendal Oak, Norwegian Ash, Gessato Oak, Cashmere



Primo: Beech, Natural Oak, Polish Oak
3D Look: Oiled Oak, Sonoma Oak, Riviera Oak, Honey Catania, Cleveland Oak
Iridium: Snow Ash, Brown Ash, Marone Oak
CPL: Hamilton Oak



Primo: Acacia St, Walnut
3D Look: Burnt Oak, Catania Oak
CPL: Italian Walnut

STEEL PULL HANDLES



Primo
3D Look
Iridium
CPL
Lacquered

Classen sliding doors are available in all decors from the following groups (details on page 160–163) and optionally in RAL palette colours.

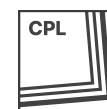
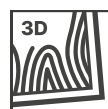

AERO

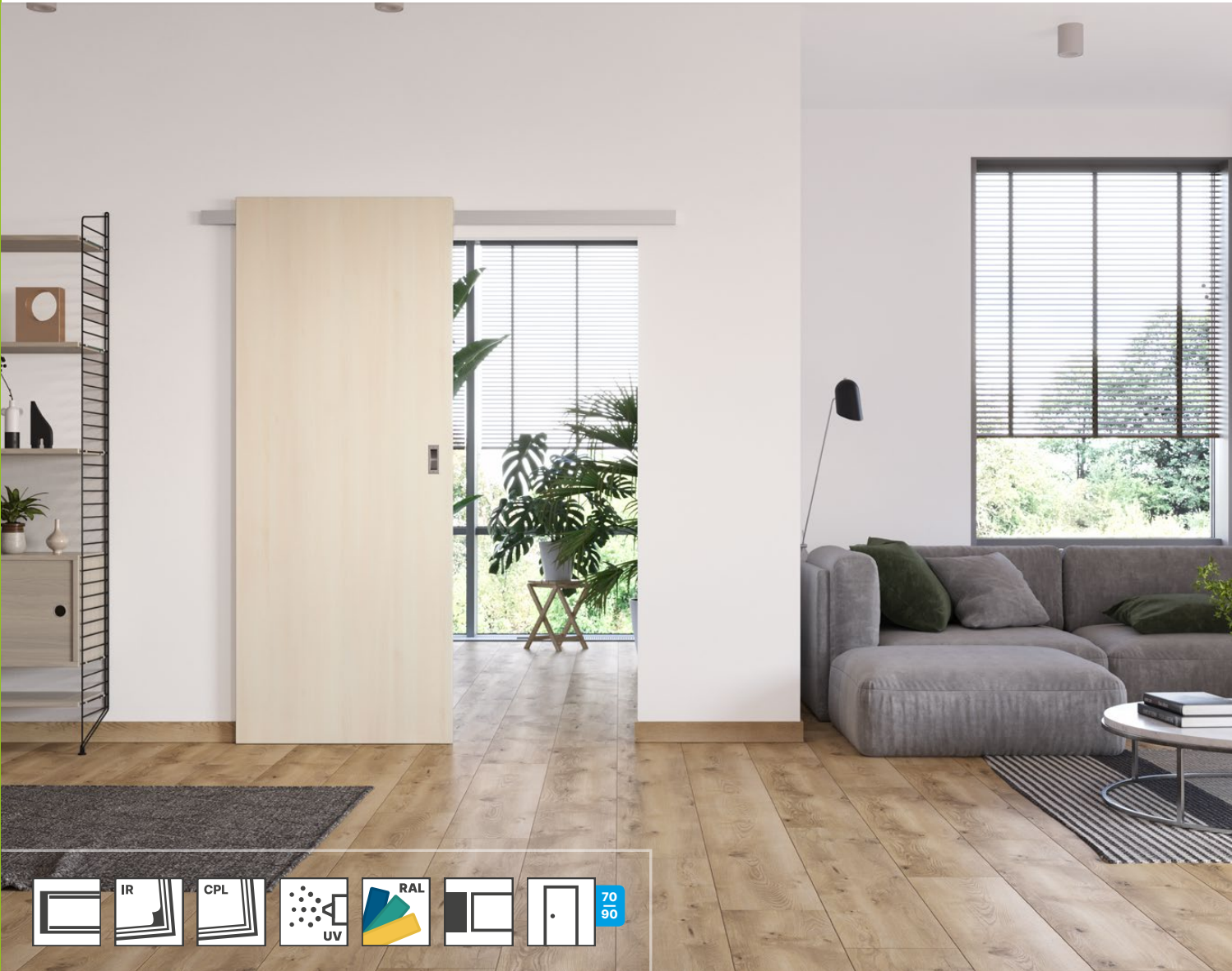

Thanks to a wide, aluminum rail, partially recessed in the door leaf, Aero System creates an aesthetic and modern combination of the door and the sliding system.

The system consists of the mechanism and the door leaf and is designed for mounting directly on the wall (no possibility of assembly with the tunnel).



DOOR LEAF WITH A RAIL – CONNECTION METHOD

DOOR LEAF

- Sliding, single leaf, solid, HARD construction, equipped with stainless steel INOX pull handle as a standard. Dedicated exclusively to Aero system.
- Door leaf dimensions - 744, 844, 944 x 2135 mm.

MECHANISM

- A full set consists of a 2 m aluminum rail, hardware and installation instruction.
- Two types of mechanism are available – standard one and with a self-closing system. After installing the system, the gap between the leaf and the wall is 12 mm.

EXTRA-COST OPTIONS

- RAL palette colours

¹ | Decor is available while stocks last.



	DOOR LEAF HEIGHT H_d	WALL OPENING HEIGHT H_o	DOOR LEAF WIDTH S_d	WALL OPENING WIDTH S_o
70"	2135	2000	744	700
80"			844	800
90"			944	900

AERO SYSTEM DIMENSION TABLE

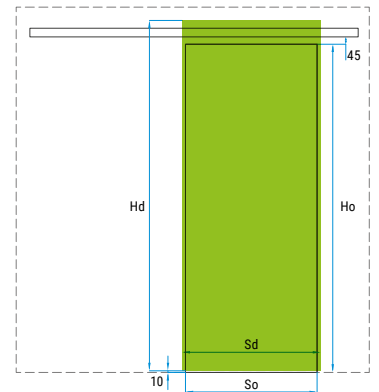

IRIDIUM



UNI BLACK



GRAPHITE ASH

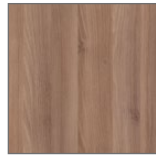

BROWN ASH



SNOW ASH 1

CPL



CASHMERE



HAMILTON OAK VERTICAL



HAMILTON OAK HORIZONTAL

CPL



ITALIAN WALNUT



LIGHT ACACIA



NORWEGIAN ASH



GRIGIO OAK



KENDAL OAK



WHITE RAL 9003



WHITE WITH HORIZONTAL STRUCTURE

CPL



GRAY RAL 7047



GRAPHITE RAL 7024

LACQUER



WHITE UV

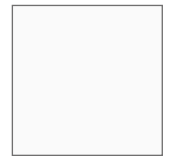

WHITE UV PURE

MODI DESIGN NEW!



A modern sliding system perfect for loft interiors. The black steel rail and all other elements of the set give the whole a unique industrial character.

The system is designed for installation directly on the wall, available only in a single-leaf version.

Door leave height: 2035 mm, available in widths 70', 80', 90' with a black recessed steel handle. Doors must be purchased separately, they are available in all collections and decors except: Classic, Andromeda, Salvano.

Required door opening height max. 2015 mm, opening width 100 mm smaller than the leaf width. After installing the system, there is a 9 mm gap between door leaf and the wall.

PACKAGE

- Includes a complete sliding system with a 1950 mm long rail. A door closer is also available for an extra charge.

EXTRA-COST OPTIONS

STOPPER



SLIDING SYSTEM WITH A STOPPER

SELF-CLOSING SYSTEM



SILENT, SELF-CLOSING SYSTEM

STEEL PULL HANDLES



STEEL
BLACK

SLIDING POCKET DOOR SYSTEM - ECLISSE



POCKET MODEL	LIGHT OPENING L X H	EXTERNAL DIMENSIONS			THICKNESS OF POCKET / WALL ¹	INTERNAL DIMENSIONS	DOOR LEAF DIMENSIONS	
		C X H1	A	B			LP	HP
G60 plus	610 x 2030	1346 x 2120	670	640	100 ²	54	644	2035
G70 plus	710 x 2030	1546 x 2120	770	740			744	
G80 plus	810 x 2030	1746 x 2120	870	840			844	
G90 plus	910 x 2030	1946 x 2120	970	940			944	
G100 plus ²	1010 x 2030	2146 x 2120	1070	1040			1044	

SINGLE POCKET DIMENSION TABLE

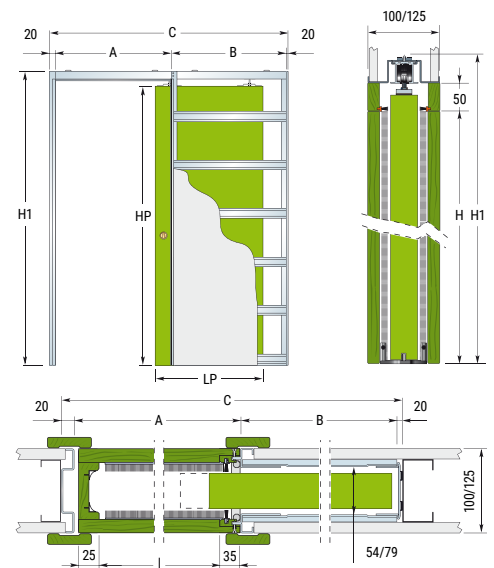

POCKET MODEL	LIGHT OPENING L X H	EXTERNAL DIMENSIONS			THICKNESS OF POCKET / WALL ¹	INTERNAL DIMENSIONS	DOOR LEAF DIMENSIONS	
		C X H1	A	B			LP	HP
GG60 plus	1220 x 2030	2600 x 2120	1290	640	100 ²	54	644	2035
GG70 plus	1420 x 2030	3000 x 2120	1490	740			744	
GG80 plus	1620 x 2030	3400 x 2120	1690	840			844	
GG90 plus	1820 x 2030	3800 x 2120	1890	940			944	
GG100 plus	2020 x 2030	4200 x 2120	2090	1040			1044	

DOUBLE POCKET DIMENSION TABLE

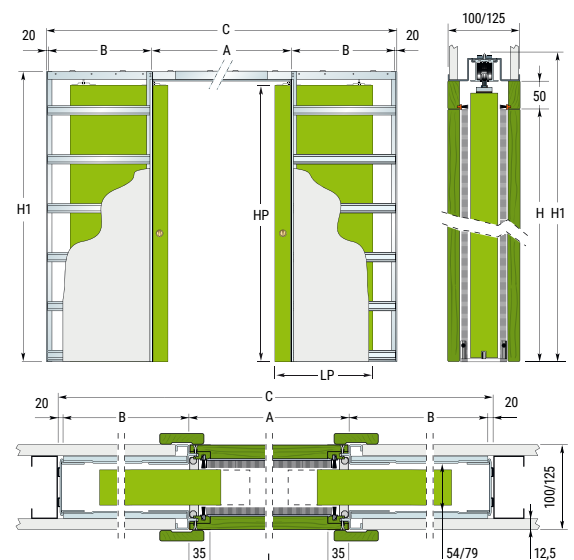

¹ IT IS NOT POSSIBLE TO INSTALL ECLISSE SLIDING SYSTEMS IN COMBINATION WITH THE SALVANO AND ANDROMEDA COLLECTIONS.

¹ Eclisse door frames for non-standard wall thickness should be ordered in line with the order form. Door frame decors: Primo, 3D Look, Iridium and CPL.

² Pocket with a thickness of 100 mm – possibility of assembly of all collections except for glazed models in panel doors. Decor is available while stocks last.

Wood-based door frames

This group of door frames is intended for everyday use door leaves used in apartments and offices. All these frames can be used with lacquered, frame and panel doors produced by Classen.

In this section you will find frames of a universal character, e.g. Adjustable or Standard 2-pack fixed, but also the more decorative ones, such as Arcus and New Arcus. The CMOK door frame, on the other hand, is a product intended for installation on the old type of steel door frames without the need to disassemble them.



ADJUSTABLE



PAGE 128

ADJUSTABLE 80



PAGE 128

ADJUSTABLE NON-REBATED



PAGE 129

ADJUSTABLE 80 NON-REBATED



PAGE 129

NEW ARCUS



PAGE 131

ARCUS



PAGE 130

View from the inner side of the leaf. Outer side as in the Standard 2-Pack fixed door frame.

STANDARD 2-PACK FIXED



PAGE 132

CMOK



PAGE 133

ADJUSTABLE / ADJUSTABLE 80



EXECUTION STANDARD

- Adjustable door frames are made of chipboard and MDF, covered with Classen decors or lacquered, in colours corresponding to door leaves colours.
- Also available in Tunel version.

Packaging:

- Complete door frame consists of an upper beam and a base and it constitutes one package. The set includes hardware, gaskets and an assembly set. For door leaves with the dimension of 100' or reinforced leaves, it is required to use door frame with three hinges.

COLOURS

Primo

- Acacia ST, White, Natural Oak, Beech, Polish Oak, Walnut

3D Look ¹

- Gessato Oak, Honey Catania, Claveland Oak, Burnt Oak ², Oiled Oak, White Ash, Sonoma Oak, Colombia Light Walnut, Riviera Oak, Gray Oak, Anthracite Oak, Catania Oak

Iridium

- UNI White ¹, UNI Black ¹, Gray Matt ¹, Snow Ash ², Brown Ash, Graphite Ash ¹, Wenge, Marone Oak ¹

CPL

- Cashmere ¹, Hamilton Oak Vertical ¹, Light Acacia ¹, White 9003 ¹, Gray 7047, Graphite 7024, Italian Walnut ¹, Norwegian Ash ¹, Kendal Oak ¹, Grigio Oak ¹, White with horizontal structure

Lacquer ¹

- lacquer: White UV or PU

EXTRA-COST OPTIONS

- third hinge
- door frame 100'
- door frame 110'
- door frame 120'
- PN 22 door frame height
- PN 23 door frame height
- band 80
- door frame for double leaf door
- RAL colours

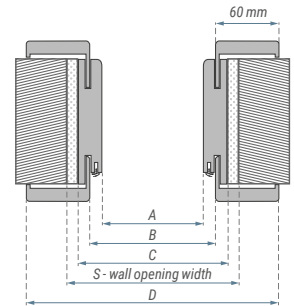
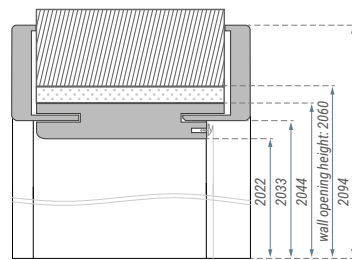
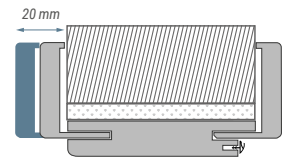
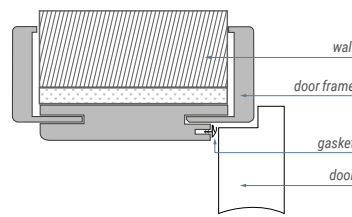

▲ ADJUSTABLE DOOR FRAME

▼ ADJUSTABLE 80 DOOR FRAME

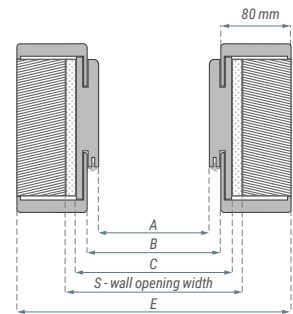
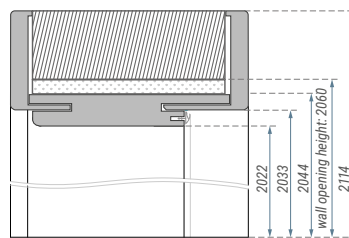

Crowns and a cover strip are designed for installation with Adjustable door frame (single leaf).

More information on page 153.

Dimensions of the adjustable door frame [mm]:

Adjustment range [mm]:

	A	B	C	D	E	S	A	B	C	D	E	S	75-95	220-240			
60	603	625	648	748	788	675	100	1038	1061	1083	1183	1223	1110	95-115	240-260		
70	703	726	748	848	888	775	110	1138	1161	1183	1283	1323	1210	120-140	260-280		
80	803	826	848	948	988	875	120	1238	1261	1283	1383	1423	1310	140-160	280-300		
90	903	926	948	1048	1088	975	130	1338	1361	1383	1483	1523	1410	160-180	300-320		
100	1003	1026	1048	1148	1188	1075	140	1438	1461	1483	1583	1623	1510	180-200	320-340		
110	1103	1126	1148	1248	1288	1175	150	1538	1561	1583	1683	1723	1610	200-220	340-360		
120	1203	1226	1248	1348	1388	1275	160	1638	1661	1683	1783	1823	1710				
SINGLE LEAF							170	1738	1761	1783	1883	1923	1810				
							180	1838	1861	1883	1983	2023	1910				
							190	1938	1961	1983	2083	2123	2010				
							200	2038	2061	2083	2183	2223	2110				
							DOUBLE LEAF										

¹ | Adjustable 80 door frame available in marked decors. Not available in Natura HK CPL - PN22 and PN23 models.

² | Decor is available while stocks last.

NON-REBATED ADJUSTABLE / ADJUSTABLE 80



EXECUTION STANDARD

- Adjustable Non-rebated door frames are made of chipboard and MDF, covered with Classen decors or lacquered, in colours corresponding to door leaves colours. Door frames dedicated for non-rebated door leaves.

Packaging:

- Complete non-rebated door frame consists of an upper beam and a base and it constitutes one package. The set includes two non-rebated hidden hinges, gaskets and an assembly set.

COLOURS

Iridium

- UNI White ¹, UNI Black ¹, Marone Oak, Snow Ash ², Brown Ash, Graphite Ash ¹, Gray Matt ¹, Wenge
- Cashmere ¹, Hamilton Oak Vertical ¹, Light Acacia ¹, White 9003 ¹, Gray 7047, Graphite 7024, Italian Walnut ¹, Norwegian Ash ¹, Kendal Oak ¹, Grigio Oak ¹, White with horizontal structure.

Lacquer ¹

- lacquer: White UV or PU

EXTRA-COST OPTIONS

- door frame 100'
- band 80
- RAL colours

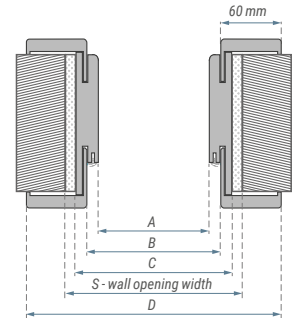
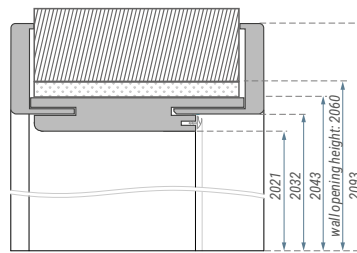
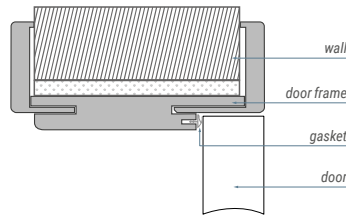

▲ ADJUSTABLE NON-REBATED DOOR FRAME

▼ ADJUSTABLE 80 NON-REBATED DOOR FRAME

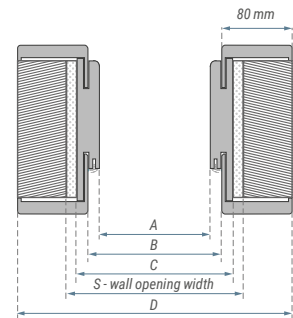
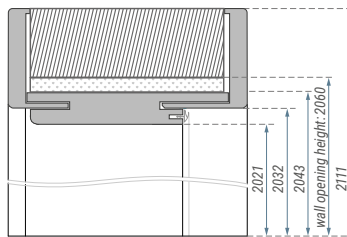

Crowns and a cover strip are designed for installation with Adjustable door frame (single leaf).



3D hinge



Strike plate with adjustment

More information on page 153.

Dimensions of the adjustable non-rebated door frame [mm]:

	A	B	C	D	E	S
60	601	624	646	746	786	690
70	701	724	746	846	886	790
80	801	824	846	946	986	890
90	901	924	946	1046	1086	990
100	1001	1024	1046	1146	1186	1090

Adjustment range [mm]:

90-110	235-255
110-130	255-275
135-155	275-295
155-175	295-315
175-195	315-335
195-215	335-355
215-235	355-375

¹ | Adjustable 80 door frame available in marked decors. Not available in Natura HK CPL - PN22 and PN23 models.

² | Decor is available while stocks last.

ARCUS

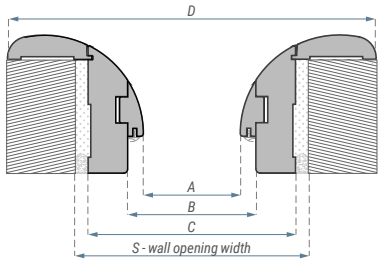
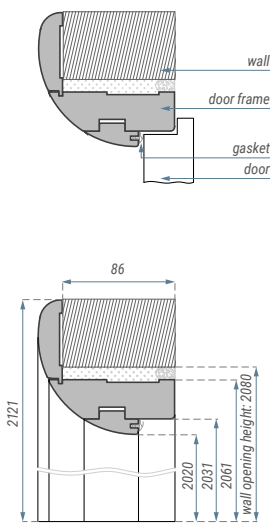

EXECUTION STANDARD

- Arcus door frames are made of MDF, covered with Primo, 3D Look and Iridium veneer and Classen CPL laminate in decors corresponding to door leaves decors. Base elements have been integrated on one side with finishing mouldings.
- Also available in Tunel version.

Packaging:

- Complete door frame consists of an upper beam and a base (two separate packages), equipped with two silver pintle hinges (the third hinge – as an extra-cost option). For door leaves with the dimension of 100' or reinforced leaves, it is required to use door frame with three hinges.

COLOURS

Primo

- Acacia ST, White, Natural Oak, Polish Oak, Walnut

3D Look

- Burnt Oak ¹, White Ash, Colombia Light Walnut, Gray Oak

Iridium

- Brown Ash, Graphite Ash, Wenge

CPL

- Light Acacia, Italian Walnut, Norwegian Ash, White with horizontal structure

EXTRA-COST OPTIONS

- third hinge
- door frame 100'
- door frame for double leaf door

Dimensions of Arcus door frame [mm]:

	A	B	C	D	S		A	B	C	D	S
60	602	626	686	806	710	100	1037	1061	1121	1241	1145
70	702	726	786	906	810	110	1137	1161	1221	1341	1245
80	802	826	886	1006	910	120	1237	1261	1321	1441	1345
90	902	926	986	1106	1010	130	1337	1361	1421	1541	1445
100	1002	1026	1086	1206	1110	140	1437	1461	1521	1641	1545
SINGLE LEAF						150	1537	1561	1621	1741	1645
						160	1637	1661	1721	1841	1745
						170	1737	1761	1821	1941	1845
						180	1837	1861	1921	2041	1945
						190	1937	1961	2021	2141	2045
						200	2037	2061	2121	2241	2145
						DOUBLE LEAF					

¹ | Decor is available while stocks last.

NEW ARCUS

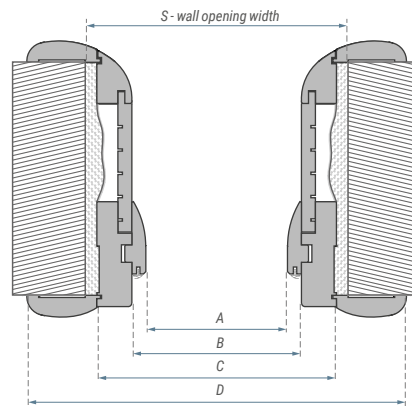
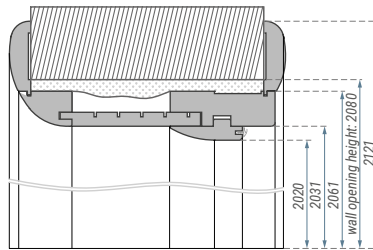
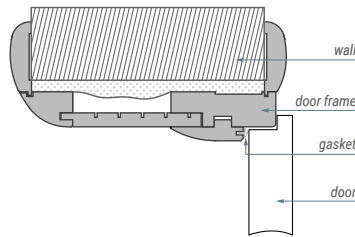

EXECUTION STANDARD

- New Arcus door frames are made of MDF, covered with Primo, 3D Look and Iridium veneer and Classen CPL laminate in decors corresponding to door leaves decors. Besides modern design, the advantage of this door frame is its universal application – for the purpose of adjustment to different wall thickness, this door frame is available in two adjustment ranges: 115-200 mm and 200-320 mm.
- Also available in Tunel version.

Packaging:

- Complete door frame consists of an upper beam and a base (two separate packages), equipped with two silver pintle hinges (the third hinge - as an extra-cost option). For door leaves with the dimension of 100' or reinforced leaves, it is required to use door frame with three hinges.

COLOURS

Primo

- Acacia St, Walnut

3D Look

- Burnt Oak ¹, White Ash, Colombia Light Walnut, Gray Oak

Iridium

- Brown Ash, Graphite Ash, Wenge, Marone Oak

CPL

- Light Acacia, Italian Walnut, Norwegian Ash, Kendal Oak, Grigio Oak

EXTRA-COST OPTIONS

- adjustment insert 200-320 mm
- third hinge
- door frame 100'
- door frame for double leaf door

Dimensions of New Arcus door frame [mm]:

	A	B	C	D	S		A	B	C	D	S
60	602	626	686	806	710	100	1037	1061	1121	1241	1145
70	702	726	786	906	810	110	1137	1161	1221	1341	1245
80	802	826	886	1006	910	120	1237	1261	1321	1441	1345
90	902	926	986	1106	1010	130	1337	1361	1421	1541	1445
100	1002	1026	1086	1206	1110	140	1437	1461	1521	1641	1545
SINGLE LEAF						150	1537	1561	1621	1741	1645
						160	1637	1661	1721	1841	1745
						170	1737	1761	1821	1941	1845
						180	1837	1861	1921	2041	1945
						190	1937	1961	2021	2141	2045
						200	2037	2061	2121	2241	2145
						DOUBLE LEAF					

¹ | Decor is available while stocks last.

STANDARD 2-PACK FIXED

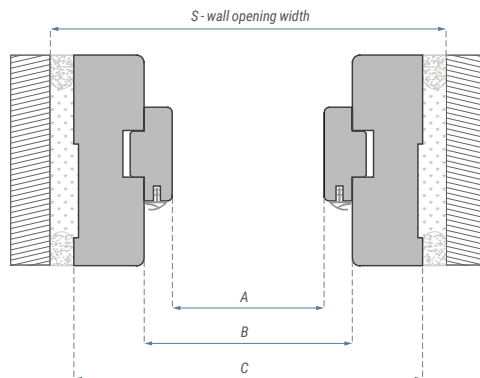
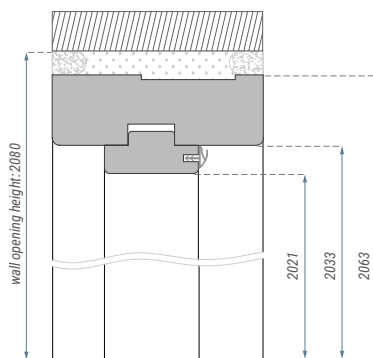
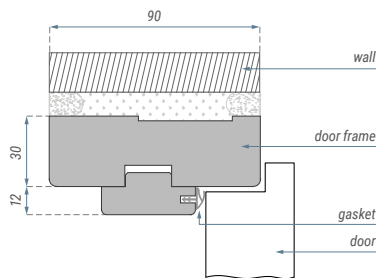

EXECUTION STANDARD

- Standard 2-pack fixed door frames are made of MDF, covered with Primo, 3D Look and Iridium veneer and CPL laminate in decors corresponding to door leaves decors.

Packaging:

- Complete door frame consists of an upper beam and a base (two separate packages), equipped with two silver pintle hinges (the third hinge – as an extra-cost option). For door leaves with the dimension of 100' or reinforced leaves, it is required to use door frame with three hinges.

COLOURS

Primo

- Acacia ST, White, Natural Oak, Beech, Polish Oak, Walnut

3D Look

- Gessato Oak, Honey Catania, Claveland Oak, Oiled Oak, Burnt Oak ¹, White Ash, Sonoma Oak, Colombia Light Walnut, Riviera Oak, Gray Oak, Anthracite Oak, Catania Oak

Iridium

- Snow Ash ¹, Brown Ash, Graphite Ash, Wenge, UNI White, UNI Black, Gray Matt, Marone Oak

CPL

- Light Acacia, Italian Walnut, White 9003, Gray 7047, Graphite 7024, Norwegian Ash, Kendal Oak, Grigio Oak, White with horizontal structure

Lacquer

- White UV or PU

EXTRA-COST OPTIONS

- third hinge
- door frame 100'
- door frame 110'
- door frame 120'
- door frame for double leaf door

Dimensions of Std 2-pack door frame [mm]:

	A	B	C	S		A	B	C	S
60	602	626	686	710	100	1037	1061	1121	1145
70	702	726	786	810	110	1137	1161	1221	1245
80	802	826	886	910	120	1237	1261	1321	1345
90	902	926	986	1010	130	1337	1361	1421	1445
100	1002	1026	1086	1110	140	1437	1461	1521	1545
110	1102	1126	1186	1210	150	1537	1561	1621	1645
120	1202	1226	1286	1310	160	1637	1661	1721	1745
SINGLE LEAF					170	1737	1761	1821	1845
					180	1837	1861	1921	1945
					190	1937	1961	2021	2045
					200	2037	2061	2121	2145

DOUBLE LEAF

¹ | Decor is available while stocks last.



EXECUTION STANDARD

- Adjustable single door leaf frame, designed to be installed on steel door frame, without the need to dismantle it beforehand. It allows the exchange of door leaves while maintaining their current dimensions. A distinctive feature of this door frame is a quick and easy installation possible owing to permanent fixture of two base elements. The door frame is entirely made of wood-based material – MDF, covered with Primo, 3D and Iridium decors and CPL laminates.

Packaging:

- A complete door frame is available in two adjustment ranges: 70-110 mm and 110-150 mm. Both ranges are available in a single package, which also contains a gasket and assembly bag. For door leaves with a dimension 100' and reinforced door leaves it is required to use a door frame with three hinges.

COLOURS

Primo

- Acacia ST, Natural Oak, Beech, Polish Oak, Walnut, White

3D Look

- Sonoma Oak, White Ash, Burnt Oak ¹, Oiled Oak, Colombia Light Walnut, Riviera Oak, Gray Oak, Anthracite Oak, Catania Oak

Iridium

- Snow Ash ¹, Brown Ash, Graphite Ash, Wenge, Marone Oak

CPL

- Italian Walnut, Light Acacia, Norwegian Ash, Kendal Oak, Grigio Oak

EXTRA-COST OPTIONS

- third hinge
- door frame 100'
- door frame 110'

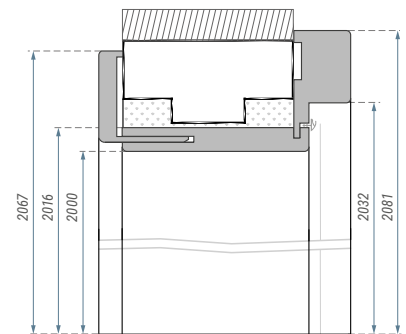
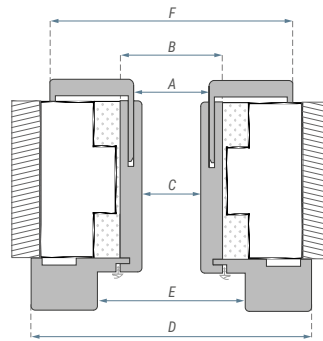
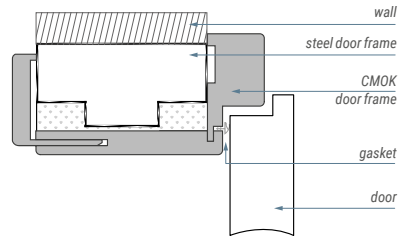

Installation - remarks:



1. Curvature of walls, on which CMOK door frame will be installed.

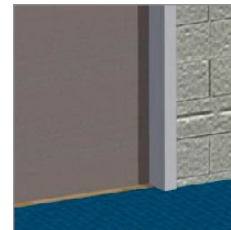

2. Floors connection point and change in the door leaf position after installing CMOK door frame.

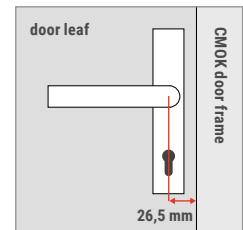

3. Handle and rosette dimensions. Door handle cannot extend beyond the spindle.

Adjustment insert

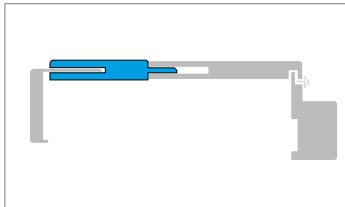

Adjustment insert 75 mm increases the adjustment range:
 – in the door frame 70-110 mm to 150-185 mm
 – in the door frame 110-150 mm to 185-220 mm

Dimensions of CMOK door frame [mm]:

	A	B	C	D	E	F
60	574	593	561	723	626	696
70	674	693	661	823	726	796
80	774	793	761	923	826	896
90	874	893	861	1023	926	996
100	974	993	961	1123	1026	1096
110	1074	1093	1061	1223	1126	1196

Adjustment range [mm]:

70-110
110-150

¹ | Decor is available while stocks last.

Steel door frames

Steel door frames are perfect for apartments and offices, but all their advantages are revealed in public utility buildings and rooms with heavy traffic. All steel door frames can be used in combination with Natura HK/HB (CPL and HPL) technical doors as well as standard lacquered frame and panel doors produced by Classen.

On the following pages you will find adjustable and fixed door frames, each of which is offered in rebated and non-rebated versions.

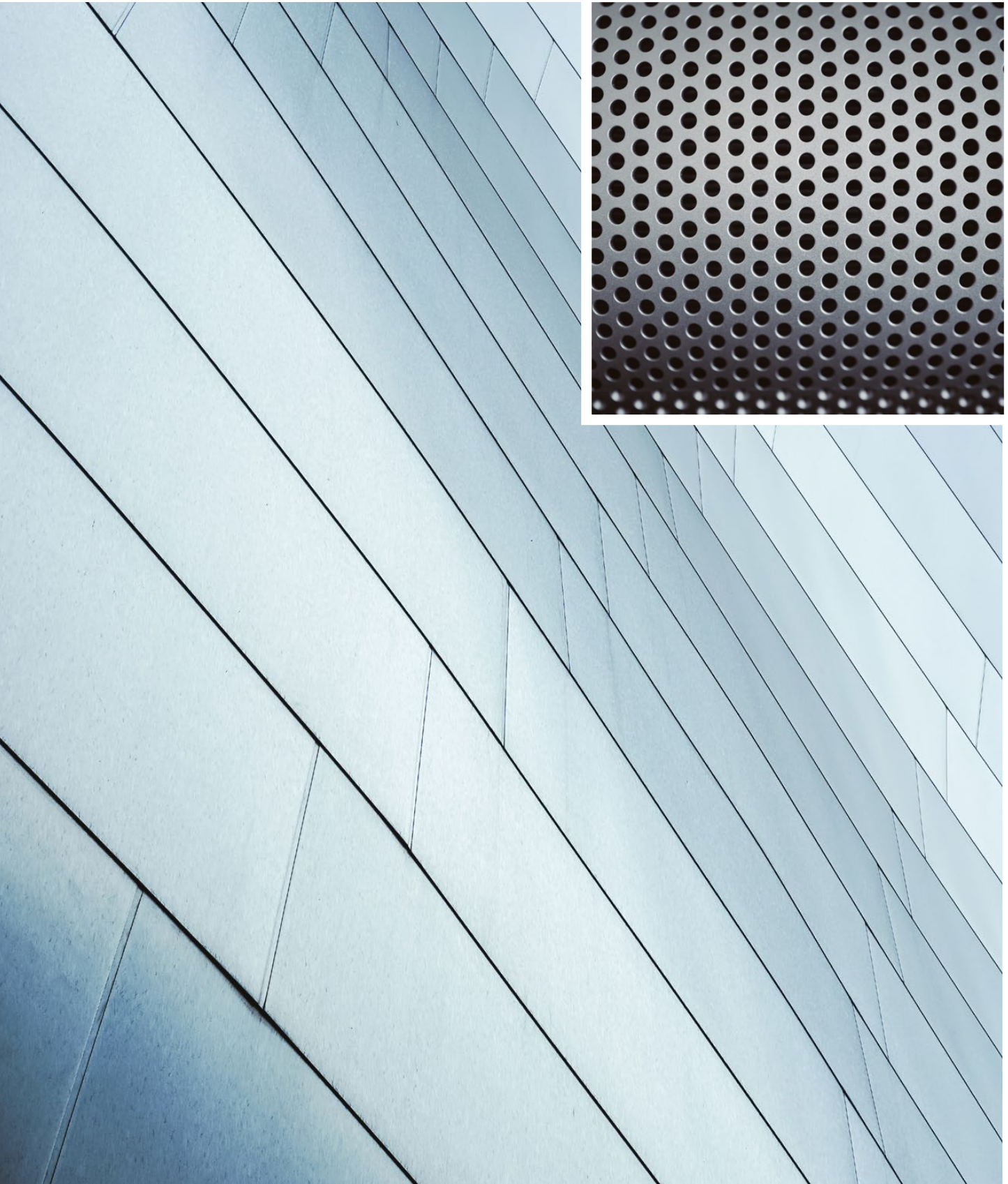

STEEL FIXED REBATED / NON-REBATED



EXECUTION STANDARD

- made of high quality steel plate, thickness 1.2 mm.
- the full door frame consists of one base element, hinges, gasket and full set of cover caps.
- gaskets available in three colours – White, Gray, Brown.
- two hidden hinges 3D as standard (non-rebated version)
- two hinges as standard; third hinge as non-extra-cost option (rebated version)
- door frame designed for installation in rooms with completed walls and floor
- non-rebated door frame available only in a single leaf version
- frame marking: rebated version FD12, non-rebated version FD93

COLOURS

- powder coated door frame. RAL colours: White (9003), Gray (7047), Graphite (7024)
- other RAL colours as well as other custom features are subject to individual pricing:
- inwestycje@classen.com.pl

EXTRA-COST OPTIONS

- reinforcement for door closer
- preparation for electric (door) strike
- execution in galvanized steel
- transition threshold
- double leaf door frames
- RAL 7024 colours

STEEL FIXED REBATED ▼

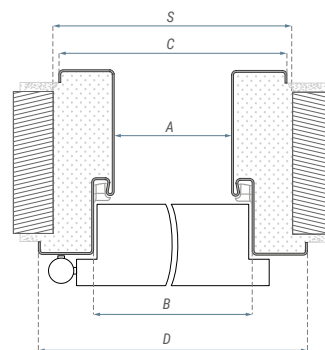
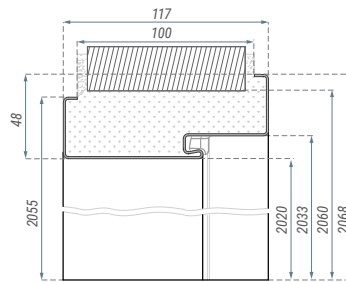
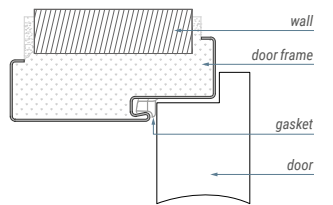

STEEL FIXED NON-REBATED ▼

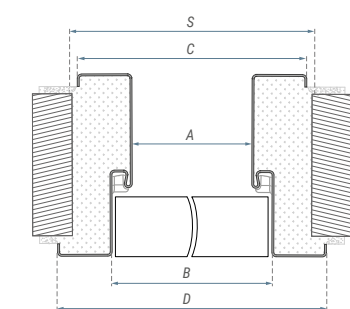
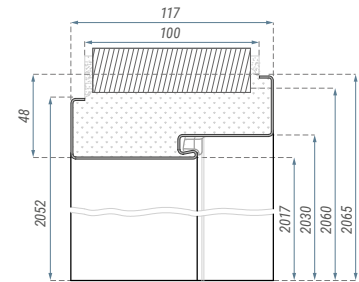
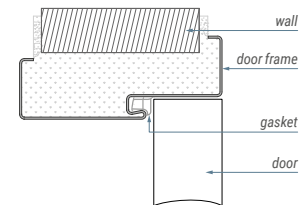

Dimensions of steel fixed and steel fixed non-rebated door frame (single leaf) [mm]:

	A	B	C	D	S		A	B	C	D	S
60	601	627	671	697	685	120	1235	1261	1305	1331	1315
70	701	727	771	797	785	130	1335	1361	1405	1431	1415
80	801	827	871	897	885	140	1435	1461	1505	1531	1515
90	901	927	971	997	985	150	1535	1561	1605	1631	1615
100	1001	1027	1071	1097	1085	160	1635	1661	1705	1731	1715
110	1101	1127	1171	1197	1185	170	1735	1761	1805	1831	1815
120	1201	1227	1271	1297	1285	180	1835	1861	1905	1931	1915
SINGLE LEAF						190	1935	1961	2005	2031	2015
						200	2035	2061	2105	2131	2115
						DOUBLE LEAF					

STEEL ADJUSTABLE

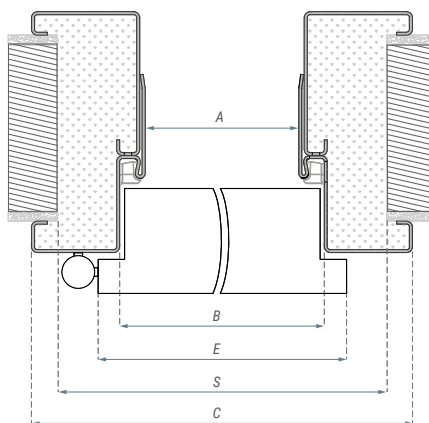
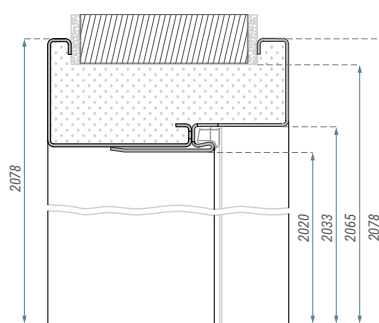
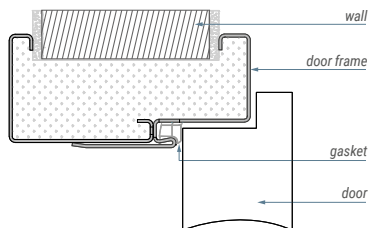

EXECUTION STANDARD

- Steel Adjustable door frames are designed for installation in different types of rooms with completed walls and floor – flats, public utility building, hotels, etc.
- Durable construction enables application both in masonry walls as well as drywalls.
- Frame marking: FD61-FD69.

Construction:

- made of high quality steel plate, thickness 1.5 mm
- a full door frame consists of a base element, adjusting part, hinges, gasket and full set of cover caps
- gaskets available in three colours – White, Gray, Brown
- two hinges as standard; third hinge as a non-extra-cost option

COLOURS

- Powder coated door frame. RAL colours: White (9003), Gray (7047), Graphite (7024).
- Other RAL colours as well as other custom features are subject to individual pricing: inwestycje@classen.com.pl

EXTRA-COST OPTIONS

- reinforcement for door closer
- preparation for electric (door) strike
- execution in galvanized steel
- RAL 7024 colours
- transition threshold
- double leaf door frames

Dimensions of the steel adjustable door frame [mm]:

	A	B	C	E	S		A	B	C	E	S
60	601	627	717	644	685	100	1035	1061	1151	1079	1120
70	701	727	817	744	785	110	1135	1161	1251	1179	1220
80	801	827	917	844	885	120	1235	1261	1351	1279	1320
90	901	927	1017	944	985	130	1335	1361	1451	1379	1420
100	1001	1027	1117	1044	1085	140	1435	1461	1551	1479	1520
110	1101	1127	1217	1144	1085	150	1535	1561	1651	1579	1620
120	1201	1227	1317	1244	1085	160	1635	1661	1751	1679	1720
SINGLE LEAF						170	1735	1761	1851	1779	1820
						180	1835	1861	1951	1879	1920
						190	1935	1961	2051	1979	2020
						200	2035	2061	2151	2079	2120

Adjustment range [mm]:

95-125	245-275
125-155	275-305
155-185	305-335
185-215	335-365
215-245	

DOUBLE LEAF

STEEL ADJUSTABLE NON-REBATED



EXECUTION STANDARD

- made of high quality steel plate, thickness 1.5 mm.
- a full door frame consists of a base element, adjusting part, hinges, gasket and full set of cover caps
- gaskets available in three colours – White, Gray, Brown
- two hidden hinges 3D as standard
- door frame designed for installation in rooms with completed walls and floor
- available only in single leaf version
- frame marking: FD71-FD79

COLOURS

- powder coated door frame. RAL colours: White (9003), Gray (7047), Graphite (7024)
- other RAL colours as well as other custom features are subject to individual pricing: inwestycje@classen.com.pl

EXTRA-COST OPTIONS

- reinforcement for door closer
- preparation for electric (door) strike
- execution in galvanized steel
- RAL 7024 colours
- transition threshold

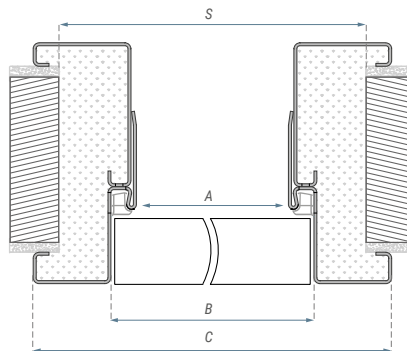
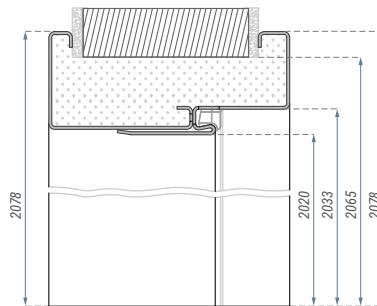
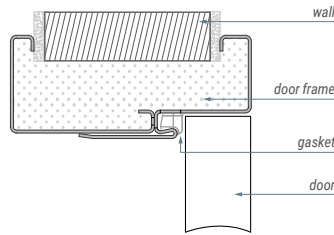

Dimensions of the adjustable non-rebated steel door frame [mm]:

	A	B	C	S
60	601	627	717	695
70	701	727	817	795
80	801	827	917	895
90	901	927	1017	995
100	1001	1027	1117	1095
110	1101	1127	1217	1195
120	1201	1227	1317	1295

Adjustment range [mm]:

110-140	260-290
140-170	290-320
170-200	320-350
200-230	350-380
230-260	

Dedicated door frames

Specialized technical doors require appropriately selected door frames. For example, fire doors do not meet their standards and are ineffective without a matching frame with fire-resistant properties.

In this section you will find frames matching Classen technical doors, such as Bord, Bord W3, acoustic and fire doors.



BORD STEEL FIXED / CORNER FIXED



EXECUTION STANDARD

- steel plate thickness 1.2 mm
- openings for top and bottom deadbolt lock (B – for steel fixed BORD door frame and steel fixed corner BORD door frame) or multipoint lock openings (W – only for steel fixed BORD door frame)
- openings for interlocking door bolts for W1 (for steel fixed BORD door frame and steel fixed corner BORD door frame) and W2 (only for steel fixed BORD door frame) door leaf versions.
- reinforcement for door closer
- single leaf 80'–100'
- frame marking: fixed FD12, fixed corner FD14

COLOURS

- powder coated door frame. RAL colours: White (9016), Gray (7047), Brown (8017), White (9003), Graphite (7024)
- other RAL colours as well as other custom features are subject to individual pricing: inwestycje@classen.com.pl

EXTRA-COST OPTIONS

- dimension 100'
- RAL 7024 colours
- transition threshold

BORD STEEL FIXED ▼

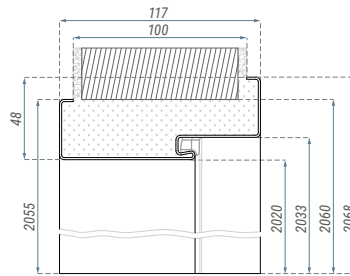
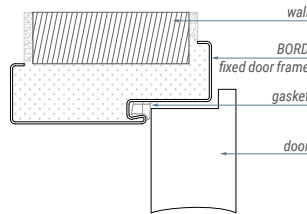

BORD STEEL CORNER FIXED ▼

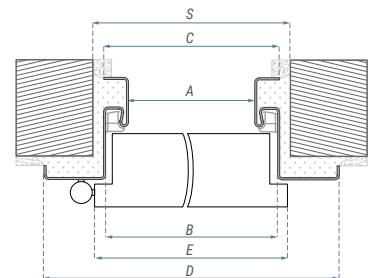
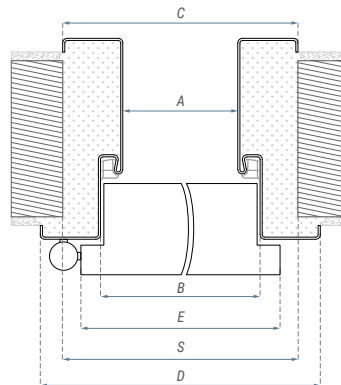
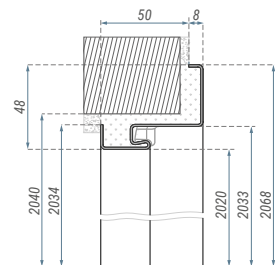
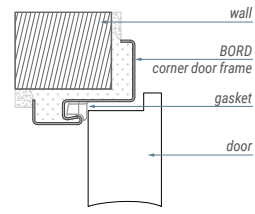

Dimensions of BORD fixed door frame [mm]:

	A	B	C	D	E	S
80	801	827	871	897	744	875
90	901	927	971	997	844	975
100	1001	1027	1071	1097	944	1075

Dimensions of BORD corner fixed door frame [mm]:

	A	B	C	D	E	S
80	801	827	829	897	844	865
90	901	927	929	997	944	965
100	1001	1027	1029	1097	1044	1065

BORD MDF FIXED

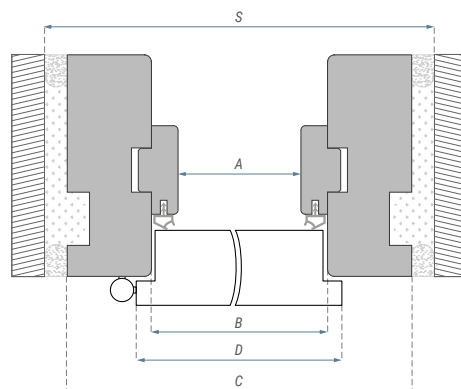
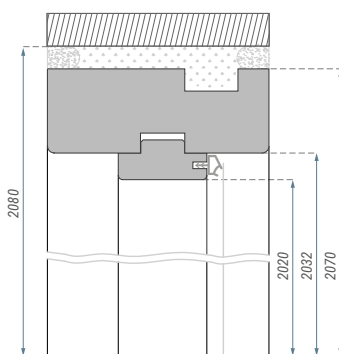
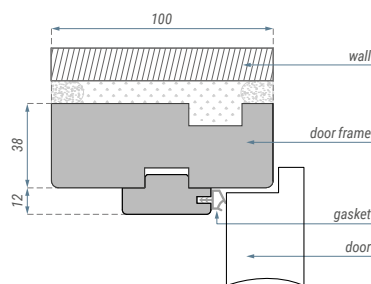

EXECUTION STANDARD

- this door frame is designed for internal entrance door leaves. It is made of MDF board, veneered with Classen decors
- surface finishing: Primo, Iridium, 3D Look, CPL
- bolt lock striking plate top and bottom (B) or multipoint lock striking plate (W)
- version W2 includes sleeves for interlocking door bolts
- single leaf 80'-100'

COLOURS

Primo

- Acacia ST, White, Natural Oak, Beech, Polish Oak, Walnut

3D Look

- Gessato Oak, Honey Catania, Claveland Oak, Oiled Oak, Burnt Oak ¹, White Ash, Colombia Light Walnut, Sonoma Oak, Riviera Oak, Gray Oak, Anthracite Oak

Iridium

- Marone Oak, Snow Ash ¹, Brown Ash, Graphite Ash, Wenge

CPL

- Italian Walnut, Light Acacia, White (RAL 9003), Gray (RAL 7047), Graphite (RAL 7024), Norwegian Ash, Kendal Oak, Grigio Oak, White with horizontal structure

EXTRA-COST OPTIONS

- dimension 100'
- fixed, wooden threshold (16 x 79 mm)
- fixed, wooden threshold (20 x 100 mm)

Dimensions of BORD MDF door frame [mm]:

	A	B	C	D	S
80	802	826	902	844	925
90	902	926	1002	944	1025
100	1002	1026	1102	1044	1125



Fixed, wooden threshold with a gasket

100 cm long threshold – for shortening by the buyer. Hardwood, protected by clear lacquer.

¹ | Decor is available while stocks last.

HYBRID

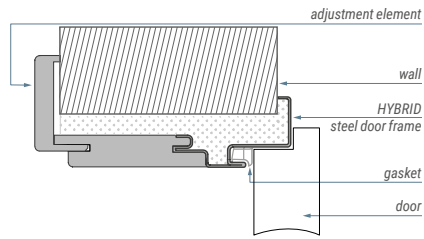

EXECUTION STANDARD

- Hybryda door frame is designed for BORD B, W and W3 internal entrance door leaves. A complete door frame consists of Hybryda steel door frame and an adjustment element.
- When installed, they create one whole. Depending on the direction of opening the door, the adjustment element may relate to the colour of the joinery inside the flat or be a decoration of the staircase.

Packaging:

- Hybryda door frame and adjustment element are packed in two separate packages.

ADJUSTMENT ELEMENT COLOURS

Iridium

- Snow Ash ¹, Brown Ash, Graphite Ash, Wenge
- **CPL**
- Light Acacia, Norwegian Ash, Italian Walnut, White (RAL 9003), Gray (RAL 7047), Graphite (RAL 7024), Grigio Oak, Kendal Oak

STEEL ELEMENT COLOURS

Powder coated

- RAL colours: White (9003), Gray (7047), Graphite (7024)

EXTRA-COST OPTIONS

- RAL 7024 colour
- transition threshold

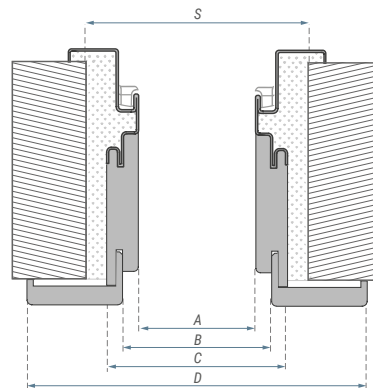
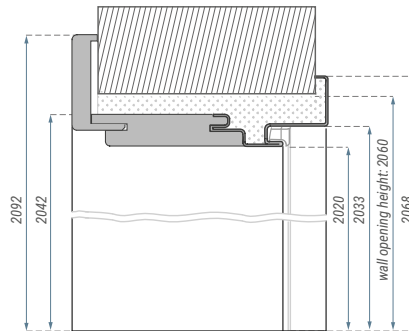

Dimensions of Hybryda door frame [mm]: Adjustment range [mm]:

	A	B	C	D	S	140-180	220-260
80	804	826	848	949	875	180-220	260-300
90	904	926	948	1049	975		
100	1004	1026	1048	1149	1075		

¹ | Decor is available while stocks last.

BORD W3 STEEL FIXED



EXECUTION STANDARD

- steel plate thickness 1.5 mm;
- complete door frame includes gasket, 3 hinges and full set of cover caps
- gaskets available in three colours – White, Gray, Brown
- openings for multipoint lock (W)
- openings for interlocking door bolts
- reinforcement for door closer
- single leaf 80'-100'
- frame marking: FD12

COLOURS

- powder coated door frame. RAL colours: Gray (7047), White (9003), Graphite (7024)
- other RAL colours as well as other custom features are subject to individual pricing: inwestycje@classen.com.pl

EXTRA-COST OPTIONS

- dimension 100'
- RAL 7024 colours
- transition threshold

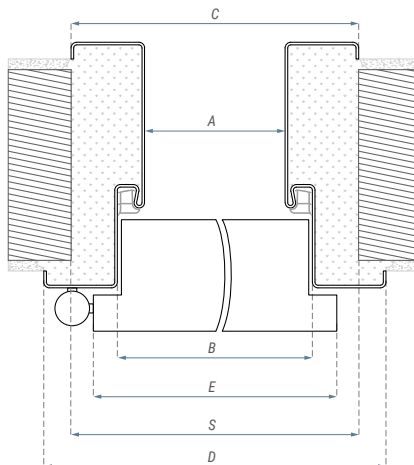
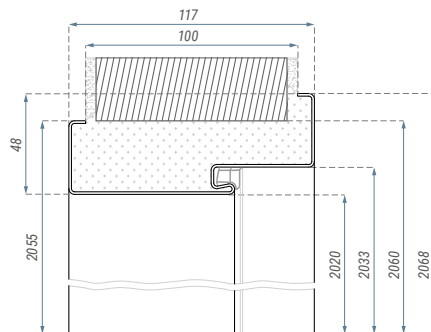
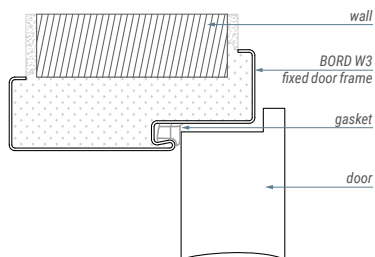

Dimensions of BORD W3 fixed door frame [mm]:

	A	B	C	D	E	S
80	801	827	871	897	844	885
90	901	927	971	997	944	985
100	1001	1027	1071	1097	1044	1085

GUARD STEEL FIXED / ADJUSTABLE



EXECUTION STANDARD

- made of high quality steel plate, thickness 1.5 mm.
- complete door frame includes gasket, hinges and full set of cover caps.
- gaskets available in three colors: White, Gray, Brown
- 3 silver three-wing hinges constitute a complete set (door + door frame)
- frame marking: fixed FD12, adjustable (depending on the adjustment range) FD61-FD69

COLOURS

- powder coated door frame. RAL colours: White (9003), Gray (7047), Graphite (7024)
- other RAL colours as well as other custom features are subject to individual pricing: inwestycje@classen.com.pl

EXTRA-COST OPTIONS

- RAL 7024 finish
- dimension 100'
- dimension 110'
- transition threshold

GUARD STEEL FIXED ▼

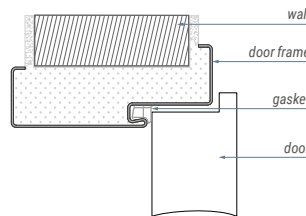

GUARD STEEL ADJUSTABLE ▼

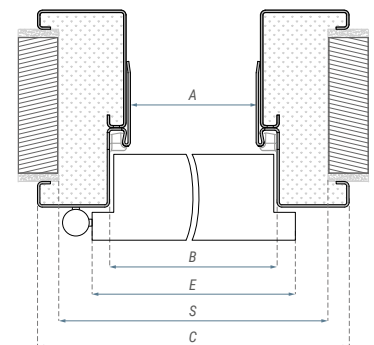
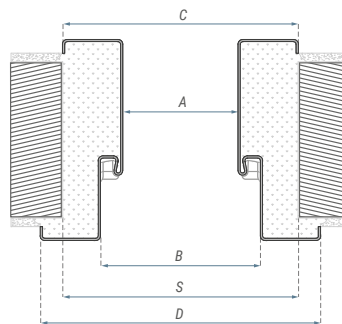
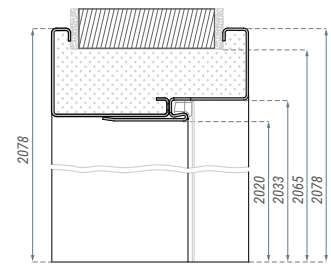
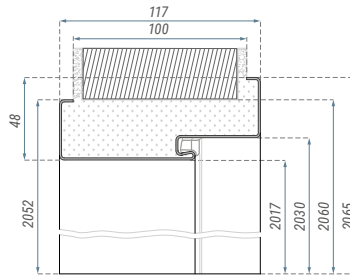
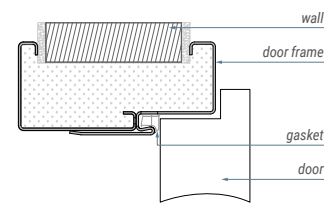

Dimensions of GUARD fixed door frame [mm]:

	A	B	C	D	S
70	701	727	771	797	785
80	801	827	871	897	885
90	901	927	971	997	985
100	1001	1027	1071	1097	1085
110	1101	1127	1171	1197	1185

Dimensions of GUARD Adjustable door frame [mm]:

	A	B	C	D	S
70	701	727	817	797	785
80	801	827	917	897	885
90	901	927	1017	997	985
100	1001	1027	1117	1097	1085
110	1101	1127	1217	1197	1185

FIRE WOODEN FIXED / ADJUSTABLE

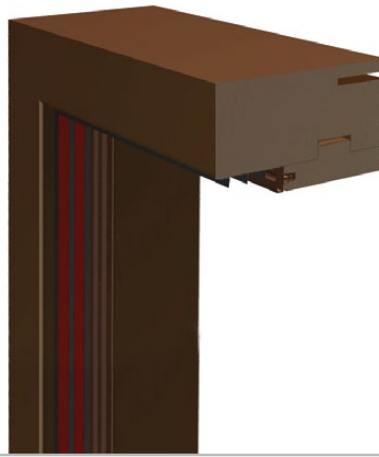

EXECUTION STANDARD - FIRE WOODEN

- FIRE wooden fixed door frame 100 mm is made of wood, veneered with Iridium decors and CPL laminates
- a complete door frame includes four adjustable hinges and a gasket
- EI30 W1/W2 version does not include expanding seals
- EI60 W1/W2 version includes expanding seal
- available dimensions – 60', 70', 80', 90', 91', 100', 101', 110'.
- double leaf door frames and other custom features are subject to individual pricing; inwestycje@classen.com.pl

Set of regulations elements for individual ranges.

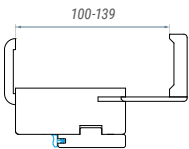

ADJUSTABLE RANGE [mm]	100-139
-----------------------	---------

For range 100-139: band tongue for self-cutting.

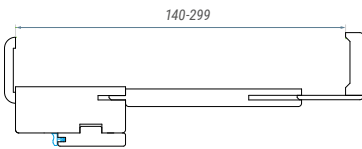

ADJUSTABLE RANGE [mm]	140-179
	180-219
	220-259
	260-299

For range 140-179: band tongue for self-cutting.

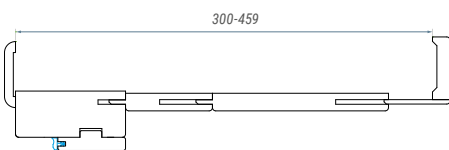

ADJUSTABLE RANGE [mm]	300-339
	340-379
	380-419
	420-459

FIRE WOODEN FIXED ▼

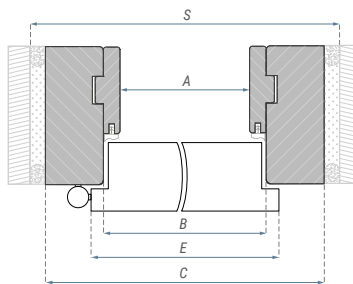
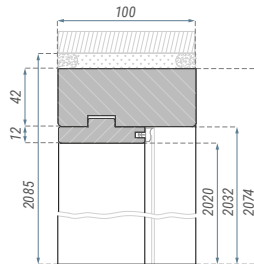
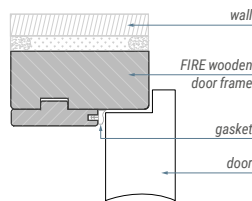

FIRE WOODEN ADJUSTABLE ▼

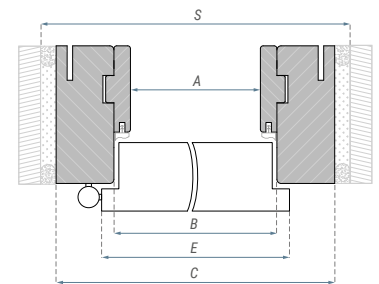
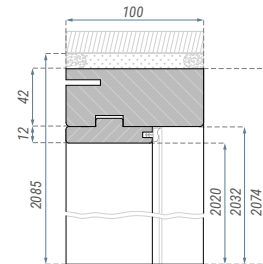
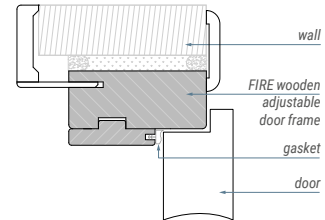

Dimensions of FIRE wooden fixed and adjustable door frame [mm]:

	A	B	C	E	S		
1-SKRZYDLOWE	80	802	826	910	844	930	
	90	902	926	1010	944	1030	
	91	914	938	1022	956	1030	
	100	1002	1026	1110	1044	1130	
	101	1014	1038	1122	1056	1130	
	110	1102	1126	1210	1144	1230	
	2-SKRZYDLOWE	100	1037	1061	1145	1079	1170
		110	1137	1161	1245	1179	1270
		120	1237	1261	1345	1279	1370
		130	1337	1361	1445	1379	1470
140		1437	1461	1545	1479	1570	
150		1537	1561	1645	1579	1670	
160		1637	1661	1745	1679	1770	
170		1737	1761	1845	1779	1870	
180		1837	1861	1945	1879	1970	
190		1937	1961	2045	1979	2070	
200	2037	2061	2145	2079	2170		

FIRE STEEL FIXED



EXECUTION STANDARD - FIRE STEEL

- FIRE steel fixed door frame is made of steel plate of thickness 1.5 mm, powder-coated in RAL colours: White (9016), Gray (7047), Brown (8017), White (9003), Graphite (7024)
- complete door frame includes four hinges and a fire-resistant gasket
- gaskets available in three colours – White, Gray, Brown
- reinforcement for door closer
- available dimensions – 80', 90', 91', 100', 101', 110'.
- EI60 double leaf door frames, other RAL colours as well as other custom features are subject to individual pricing: inwestycje@classen.com.pl

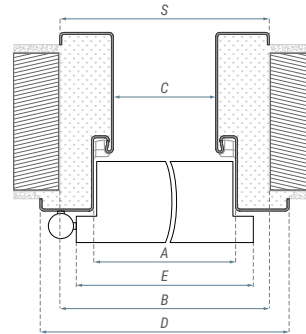
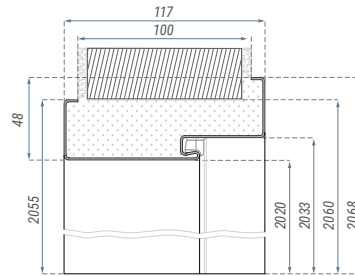
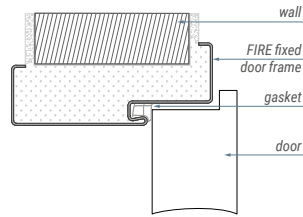

Dimensions of FIRE steel fixed door frame [mm]:

	A	B	C	D	E	S	
1-SKRZYDŁOWE	80	800	826	870	896	844	870
	90	900	926	970	996	944	970
	91	912	938	970	996	944	970
	100	1000	1026	1070	1096	1044	1070
	101	1012	1038	1070	1096	1044	1070
	110	1100	1126	1170	1196	1144	1170
	2-SKRZYDŁOWE	100	1035	1061	1105	1131	1079
110		1135	1161	1205	1231	1179	1205
120		1235	1261	1305	1331	1279	1305
130		1335	1361	1405	1431	1379	1405
140		1435	1461	1505	1531	1479	1505
150		1535	1561	1605	1631	1579	1605
160		1635	1661	1705	1731	1679	1705
170		1735	1761	1805	1831	1779	1805
180		1835	1861	1905	1931	1879	1905
190		1935	1961	2005	2031	1979	2005
200	2035	2061	2105	2131	2079	2105	

42 DB MFD FIXED REBATED



EXECUTION STANDARD - 42 DB MDF FIXED

- This door frame is designed for internal entrance rebated fire door leaves: EI30 42dB and acoustic 42dB. Door frame is made MDF board, covered with Iridium decors and CPL laminates.
- Available in dimensions 60'-90'. Complete door frame includes four hinges and a gasket.

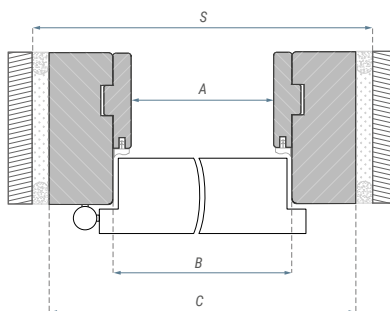
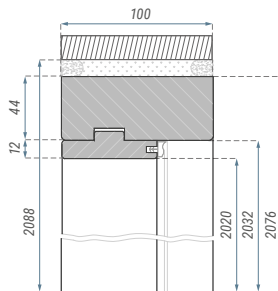
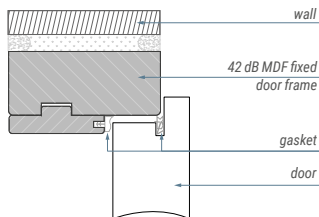

Dimensions of MDF fixed 42dB door frame [mm]:

	A	B	C	S
60	602	626	714	738
70	702	726	814	838
80	802	826	914	938
90	902	926	1014	1038

42 DB MFD FIXED NON-REBATED



EXECUTION STANDARD - 42 DB MDF FIXED NON-REBATED

- Door frame is designed for internal non-rebated fire EI30 42dB and acoustic 42db door leaves. Door frame is made MDF board, covered with Iridium decors and CPL laminates.
- Available in dimensions 60'-90'. Complete door frame includes four hidden hinges and a double set of gaskets. Milling for hidden self-closer (non-extra-cost option).

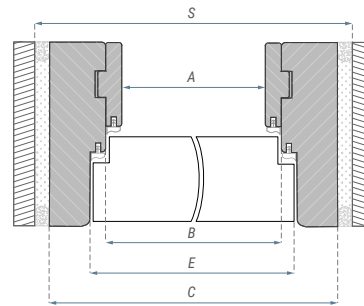
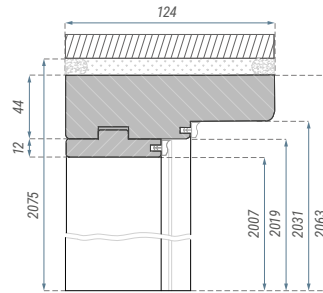
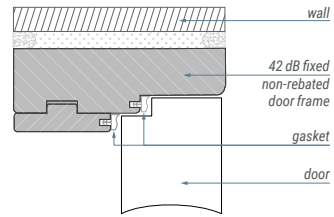

Dimensions of MDF non-rebated fixed 42dB door frame [mm]:

	A	B	C	E	S
60	638	662	750	686	774
70	738	762	850	786	874
80	838	862	950	886	974
90	938	962	1050	986	1074

THE ABC OF DOORS – information database

CORE



HONEYCOMB filling



PERFORATED CHIPBOARD filling



CLASSEN HARD reinforced construction



CLASSEN HARD EDGE PF construction for PF rebate

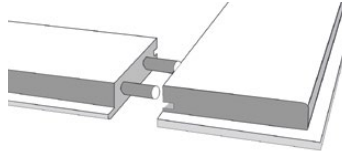

FRAME CONSTRUCTION construction elements connected with mounting pins

REBATED AND NON-REBATED DOOR LEAVES PROFILES



K PROFILE side and top edge of the door



R PROFILE side and top edge of the door



PF PROFILE postforming only on the side edge of the door



B PROFILE non-rebated

VENTILATION



PASS-THROUGH VENTILATION SLEEVES Single-coloured PVC, matching door decors



METAL VENTILATION SLEEVES satine chrome



PASS-THROUGH VENTILATION GRILLE made of plastic, matching door decors



VENTILATION UNDERCUT IN PANEL DOORS ¹
undercut 15 mm - for rooms with recuperation
undercut 26 mm - WC for doors 80'-100'
undercut 38 mm - WC for doors 60'-70'

60'-100'

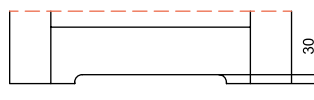

HEIGHT OF VENTILATION UNDERCUT IN FRAME DOORS, FOR WIDTH 60'-100' ²

¹ | In line with applicable rules, ventilation area in the door leaf cannot be less than 0,022 m² for air flow. These requirements are fulfilled by ventilation grille and ventilation undercut. Not applicable to Andromeda and Salvano collections, for dimensions 60' and 70'. Undercut 15 mm – for rooms with recuperation, undercut 30 mm WC for doors.

² | In frame doors with a width of 60', 70', ventilation undercut does not meet the required air throughput in accordance with applicable regulations.

THE ABC OF DOORS – information database

TYPE OF DOOR REBATE



NON-REBATED DOOR

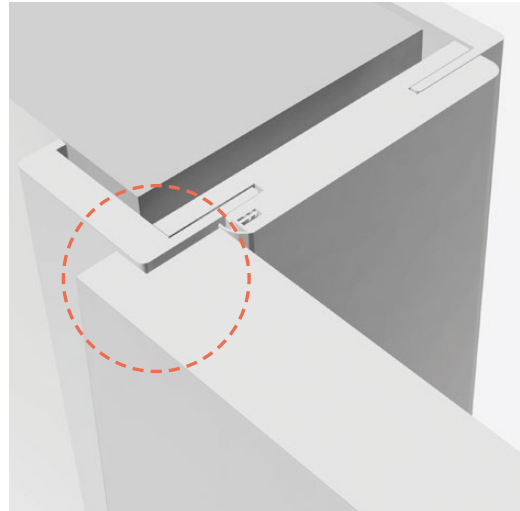

REBATED DOOR



3D HINGE



STRIKE PLATE



STRIKE PLATE



HINGE

DOOR OPENING DIRECTION

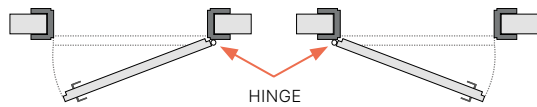

SINGLE LEAF DOOR,
RIGHT

SINGLE LEAF DOOR,
LEFT

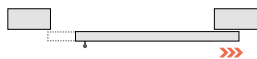

SLIDING DOOR,
RIGHT



SLIDING DOOR,
LEFT

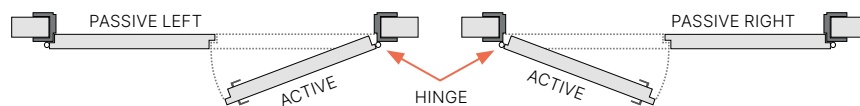
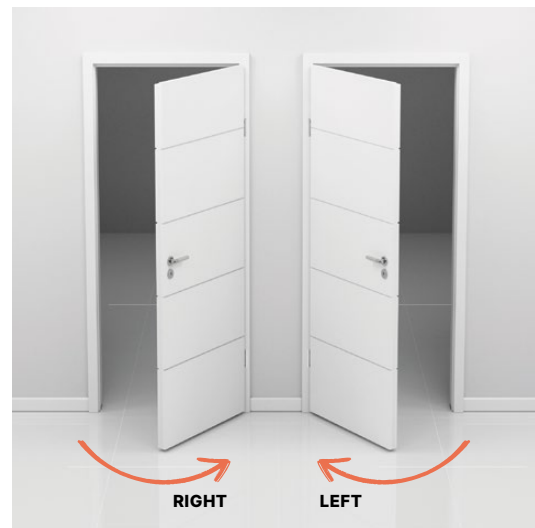

DOUBLE LEAF DOOR,
RIGHT

DOUBLE LEAF DOOR,
LEFT

ADDITIONAL ELEMENTS

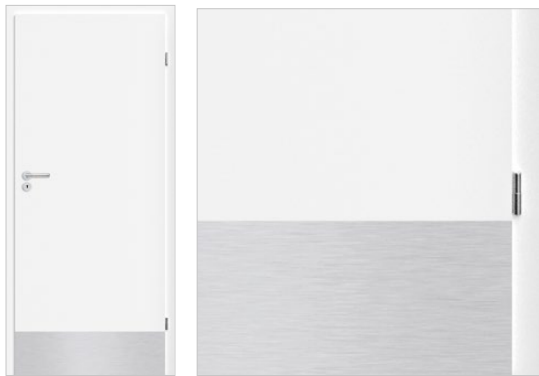

STEEL KICK-PLATE, SOLID
one-sided or two-sided

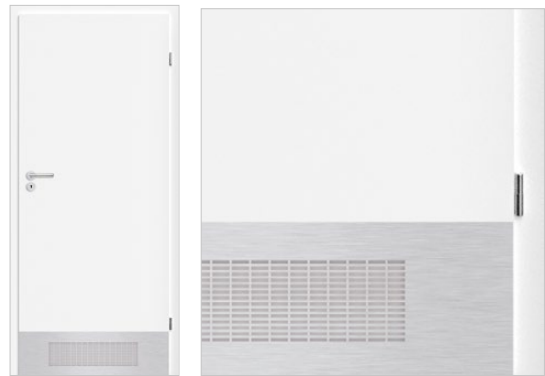

STEEL KICK-PLATE WITH VENTILATION GRILLE
two-sided



STEEL PUSH-PLATE
one-sided or two-sided

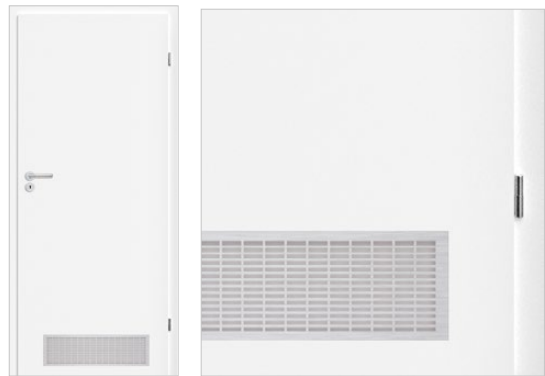

ALUMINUM VENTILATION GRILLE
two-sided



PORTHOLE
internal diameter – 240 mm, milky-white or transparent glass

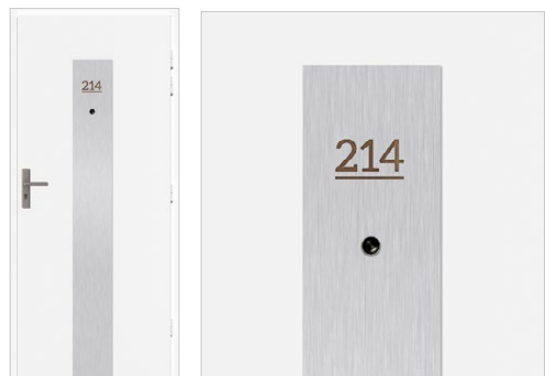

STEEL VERTICAL PUSH-PLATE
with any room number

MOULDINGS / RAL COLOURS

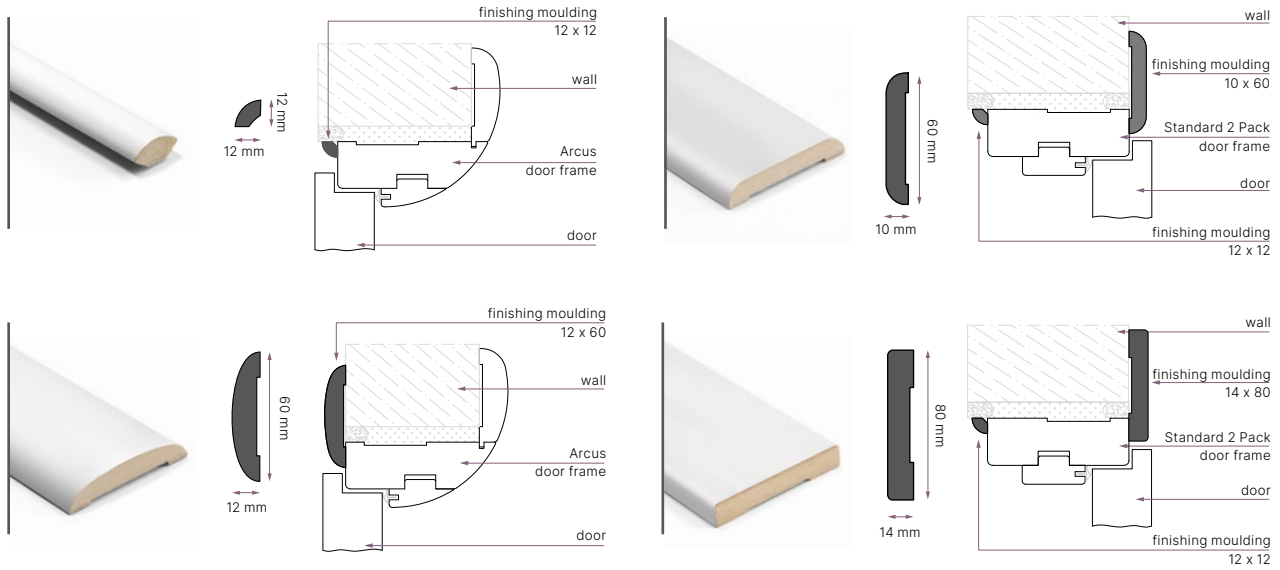

14X80 MM AS FINISHING MOULDING FOR DOORS AND AS WALL BASE MOULDING



Application:

Finishing mouldings are used for masking non-finished places of joining the walls and a door frame. 14x80 moulding can be also installed as a wall base moulding. It is possible to instal finishing mouldings with small nails.

Colours:

Available in all door decors and white lacquer.

Packaging:

One package contains three finishing mouldings to be cut to match single or double leaf doors.

For single leaf door:

2x vertical element 2160 mm, 1x beam 1160 mm.

For double leaf door:

2x vertical element 2160 mm, 1x beam 2350 mm.

ADJUSTMENT BAND WITH TONGUE 60 MM



APPLICATION

The band is an optional element designed for adjustable and adjustable 80 door frame ¹.

The band with longer tongue increases the adjustment range by 17 mm. Available in the following width: 60'-90'.

EXTRA-COST OPTIONS

width 100'

Table, door and frames RAL colour groups ²

Group	Color number
I	1013 1014 1015 7004 7032 7035 7038 7040 7044 7047 9001 9002 9010 9016
II	1000 1001 1002 1011 1019 1020 1024 3009 3012 3015 3034 5012 5014 5015 5018 6021 6027 6034 7000 7002 7003 7005 7006 7009 7023 7030 7031 7034 7036 7037 7039 7042 7045 7046 8002 8017 8024 8025 9011
III	1003 1004 1005 1012 1017 1034 3000 3014 3017 3018 3022 4001 4002 4003 4005 4006 4008 4009 4010 5000 5001 5002 5003 5005 5007 5008 5009 5011 5013 5017 5019 5020 5021 5022 5023 6000 6003 6006 6008 6010 6011 6012 6014 6015 6016 6017 6020 6022 6024 6026 6028 6032 6033 7008 7013 7024 7026 8000 8001 8003 8004 8007 8008 8011 8014 8019 8022 8023 9005 9017
IV	1006 1007 1016 1018 1021 1023 1027 1028 1032 1033 2000 2001 2002 2003 2008 2009 2010 2011 2012 3001 3002 3003 3004 3005 3007 3011 3013 3016 3020 3027 3031 4004 4007 5004 6001 6002 6004 6007 6009 6018 6025 7016 8012

¹ Available in decors as for the non-rebated adjustable 80 door frame (details on page 129).

² Minimum order quantity in the case of RAL colour finish - 3 sets (door leaf + door frame).

CROWN

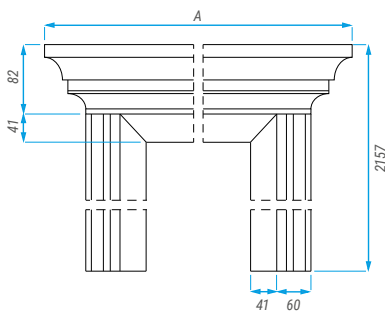

CROWN I

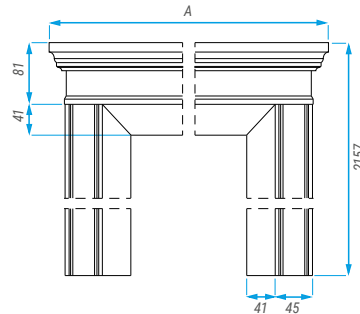

MOULDING II - LN2

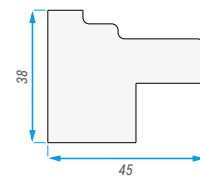
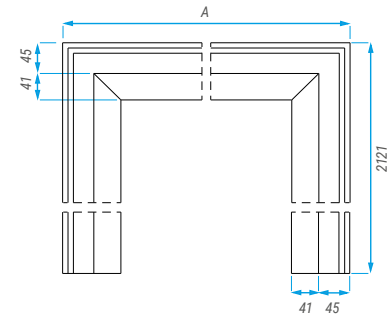

MOULDING PROFILE

CROWN AND MOULDING

Crowns and a moulding are designed for installation with Adjustable and Adjustable Non-rebated door frame (single leaf). Not available with band 80. Crowns are not adjusted for installation on a door leaf with a band 80 mm. Surface finishing: PU lacquered.

Lacquer from RAL palette as an extra-cost option. Minimum order quantity – 3 sets, door leaf + door frame + crown.

Table of optional finishes in RAL colours on page 152.

Adjustable door frame	dimension A (mm)		
	Crown	Crown I	Moulding LN2
60	900	843	800
70	1000	943	900
80	1100	1043	1000
90	1200	1143	1100
100	1300	1243	1200

ACCESSORIES

VENTILATION

PVC VENTILATION SLEEVES MATCHING THE COLOUR OF THE DOOR LEAF VENEER:



WHITE



LIGHT GRAY



LIGHT BEIGE



DARK BEIGE



BROWN



DARK BROWN



GRAPHITE

VENTILATION GRILLES



GRILLE FOR TECHNICAL DOORS aluminium



WHITE plastic



LIGHT BEIGE plastic



DARK BEIGE plastic



GRAY plastic



ORANGE plastic



DARK BROWN plastic



GRAPHITE plastic

LOCKS



REBATED DOOR LEAVES LOCK left and right version mortice key lock / cylinder lock / WC (4x4)



REBATED DOOR LEAVES LOCK black, left and right version mortice key lock / cylinder lock / WC (4x4)



STRIKE PLATE black



MAGNETIC LOCK for non-rebated doors mortice key lock / cylinder lock / WC (6x6)



MAGNETIC LOCK black, for non-rebated doors mortice key lock / cylinder lock / WC (6x6)



STRIKE PLATE black, for non-rebated doors



HOOK LOCK for sliding doors mortice key lock / WC lock



DEADBOLT LOCK bottom, Bord left / right



DEADBOLT LOCK top Bord



FIRE LOCK



CYLINDER LOCK Designed for cylinder locks, 26/36 mm



SET OF CYLINDER LOCKS Designed for cylinder locks, 26x40 class II (BORD W3)

ACCESSORIES

HINGES



3D HINGE
for non-rebated doors
nickel or black



DOOR FRAME HINGE



PANEL DOOR HINGE



FIRE HINGE
wooden door frame



FIRE HINGE / GUARD
steel door frame

DOOR STOPS / PEEPHOLES



WALL DOOR STOP
nickel cone



WALL DOOR STOP
nickel square



FLOOR DOOR STOP
nickel spherical



FLOOR DOOR STOP
bronze spherical



PEEPHOLE
nickel



PEEPHOLE
grafiatto bronze

PCV PULL HANDLES

ROUND - FOR SLIDING DOORS



WHITE



SILVER



GOLDEN



BEIGE



BROWN

DOOR CLOSERS



DC140 SURFACE MOUNTED DOOR CLOSER
with standard arm for FIRE door



DC135 DOOR CLOSER
with sliding rail for FIRE door



DOOR CLOSER
for sliding doors system

OTHER ACCESSORIES

NEW!



DOOR PULL HANDLE
for sliding doors, black



DOOR PULL HANDLE
for sliding doors, steel

NEW!

NEW!

NEW!



HINGE PVC COVERS
for panel doors, diameters: 13.5 mm.
Colours: white, satin, gold, black

HANDLES

NEW!

TIPO QR
black



HANDLE
with a short escutcheon plate



standard rosette



cylinder rosette



WC rosette



black

NEW!

TIPO QR
nickel



HANDLE
with a short escutcheon plate



standard rosette



cylinder rosette



WC rosette



nickel

NEW!

NOVAR
brass



HANDLE
with a short escutcheon plate



standard rosette



cylinder rosette



WC rosette



brass

NEW!

NOVAR
nickel



HANDLE
with a short escutcheon plate



standard rosette



cylinder rosette



WC rosette



nickel

HANDLES

DIANA QR

satin chrome



HANDLE
with a short escutcheon plate



standard rosette



cylinder rosette



WC rosette



satin chrome

FIRE DOOR HANDLE

stainless steel



HANDLE
with a short escutcheon plate



standard rosette



cylinder rosette



WC rosette



stainless steel

ROMANA

grafiato bronze
chrome / nickel



HANDLE
with a short escutcheon plate



standard rosette



cylinder rosette



WC rosette



chrome / nickel



grafiato bronze

PRADO

stainless steel,
satin



HANDLE
with a short escutcheon plate



standard rosette



cylinder rosette



WC rosette



satin



stainless steel

HANDLES

QUBIK QR
black matt,
nickel,
titanium



HANDLE
with a short escutcheon plate



standard rosette



cylinder rosette



WC rosette



NEW!

black matt



nickel



titanium

SIGMA QR
stainless steel,
satin



HANDLE
with a short escutcheon plate



standard rosette



cylinder rosette



WC rosette



satin



stainless steel

PALERMO QR
nickel



HANDLE
with a short escutcheon plate



standard rosette



cylinder rosette



WC rosette



nickel

FOKUS QR
black,
titanium



HANDLE
with a short escutcheon plate



standard rosette



cylinder rosette



WC rosette



NEW!

black



titanium

HANDLES

NEW!

NOVA
nickel

HANDLE
with a long escutcheon plate



standard rosette



cylinder rosette



WC rosette

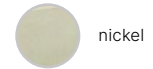

nickel

NEW!

NOVAR
brass

HANDLE
with a long escutcheon plate



standard rosette



cylinder rosette



WC rosette

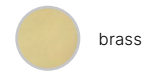

brass

ALMA ECO

grafiatto bronze,
nickel

HANDLE
with a long escutcheon plate



standard rosette



cylinder rosette



WC rosette



grafiatto bronze

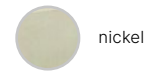

nickel

NEW!

SHARK
black,
inox



HANDLE
with a long escutcheon plate,
spacing 72 mm, upper rosette, short.

For W46 Bord door (multipoint lock)
and FIRE door.



HANDLE
with a long escutcheon plate,
spacing 90 mm, upper rosette, long.

For B40, B46 Bord door
(deadbolt lock).

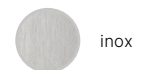

inox

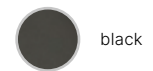

black

NEW!

DIVA class III
inox

HANDLE
with a long escutcheon
plate, spacing 72 mm,
upper rosette, short.
For W3 Bord door.



rosette for
upper lock

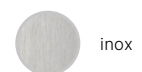

inox

VENEER

PRIMO

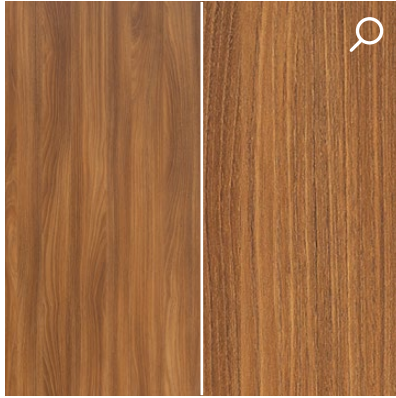

ACACIA ST

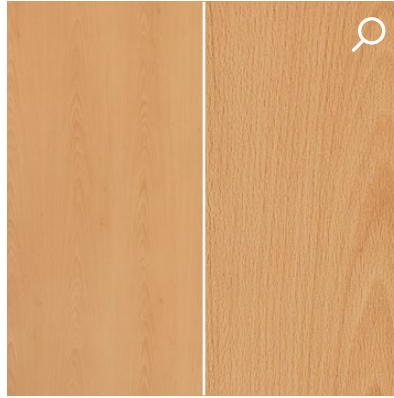

BEECH

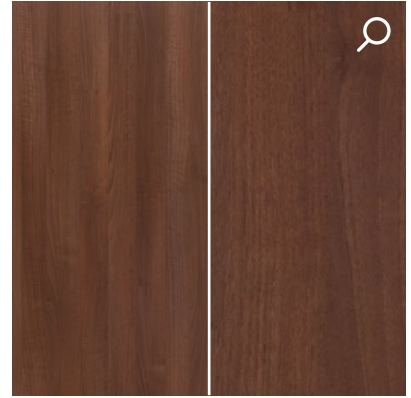

WALNUT

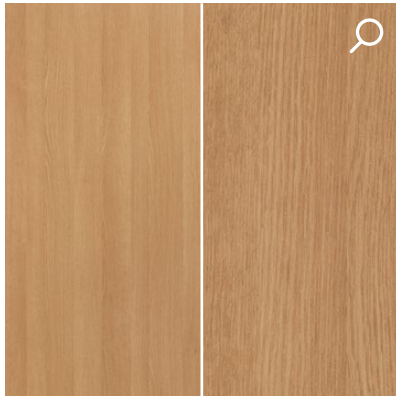

POLISH OAK

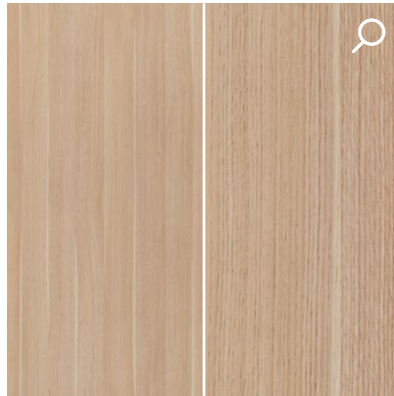

NATURAL OAK

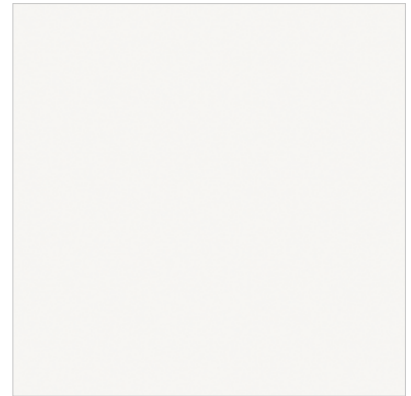

WHITE

3D LOOK

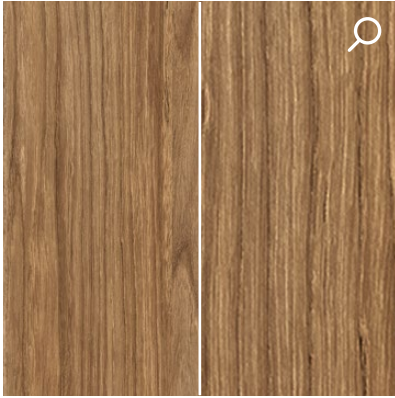

HONEY CATANIA

NEW!



GESSATO OAK

NEW!



CLEVELAND OAK

NEW!

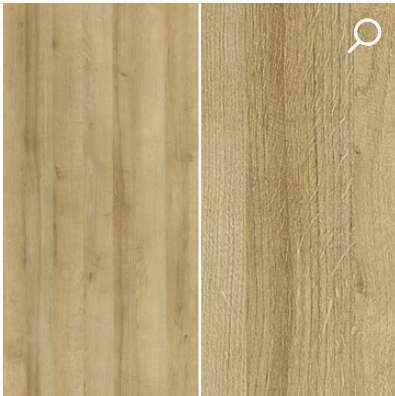

RIVIERA OAK

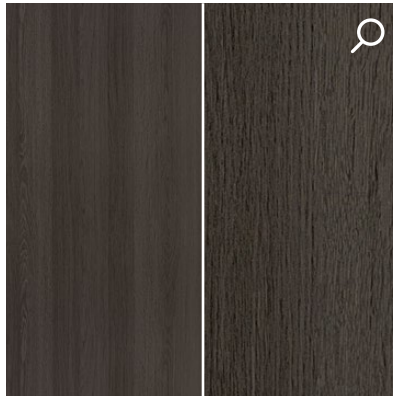

ANTHRACITE OAK

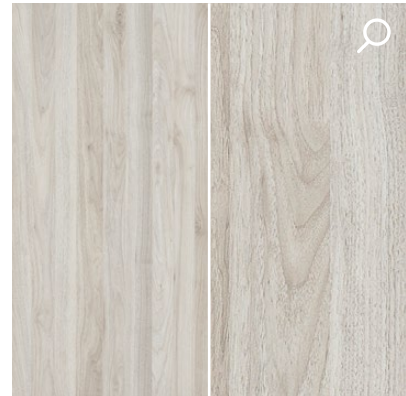

COLOMBIA LIGHT WALNUT

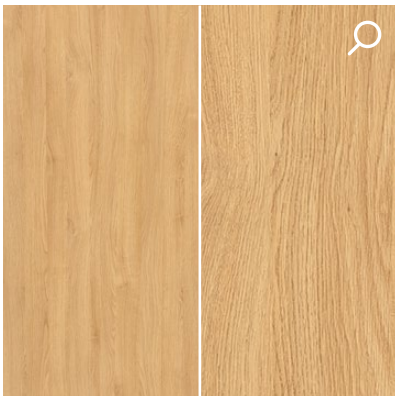

OILED OAK

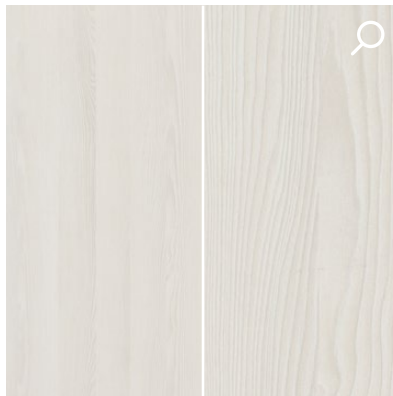

WHITE ASH

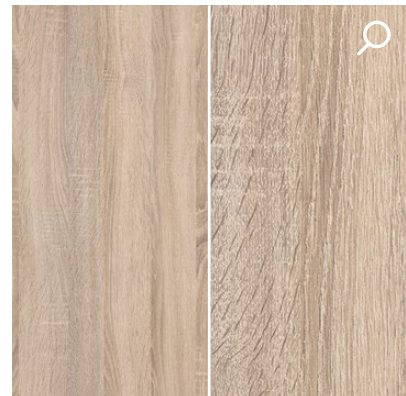

SONOMA OAK

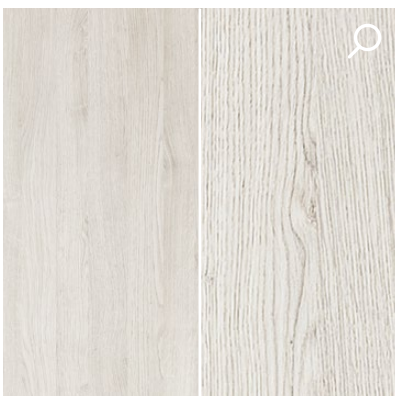

GRAY OAK

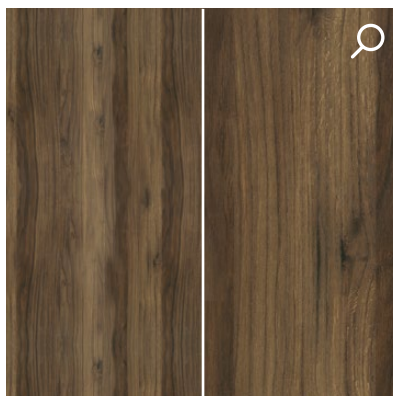

CATANIA OAK

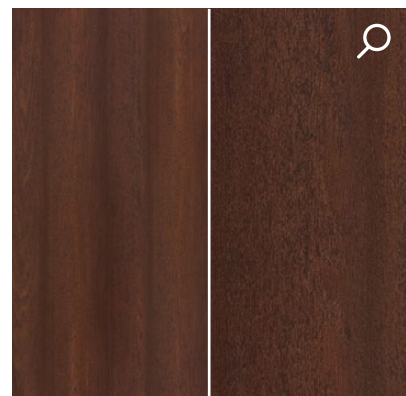

BURNT OAK

(decor is available while stocks last)

VENEER

IRIDIUM

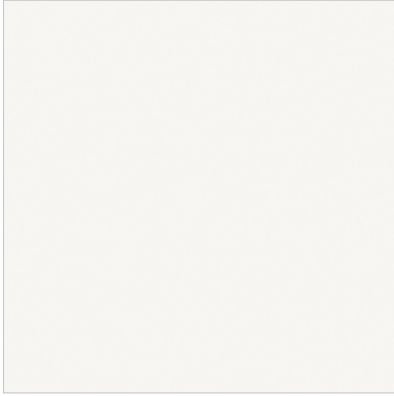

UNI WHITE

NEW!



GRAY MATT

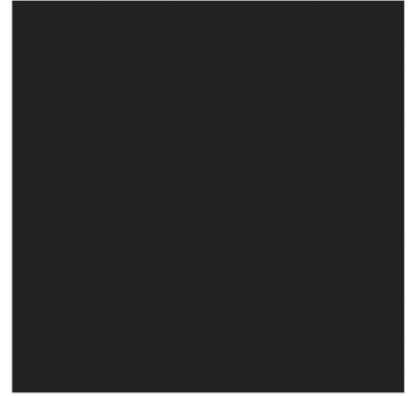

UNI BLACK

NEW!

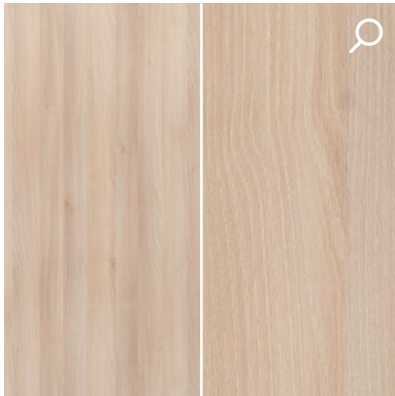

SNOW ASH
(decor is available while stocks last)

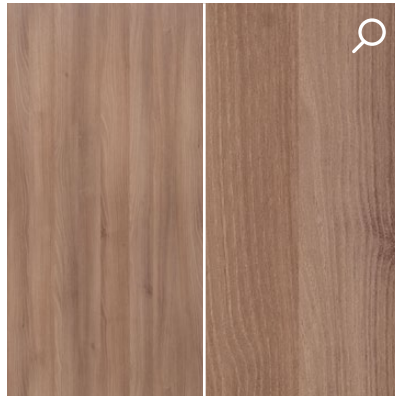

BROWN ASH

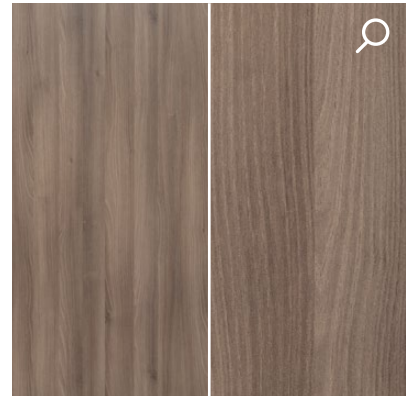

GRAPHITE ASH

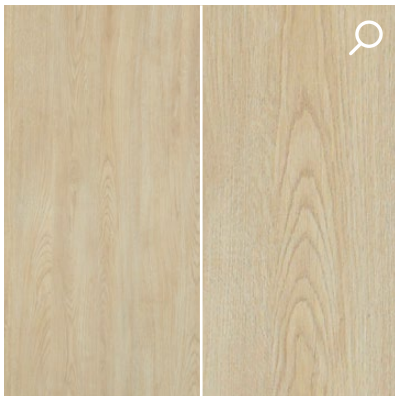

MARONE OAK

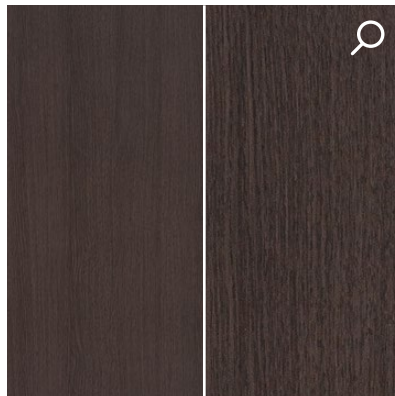

WENGE

CPL

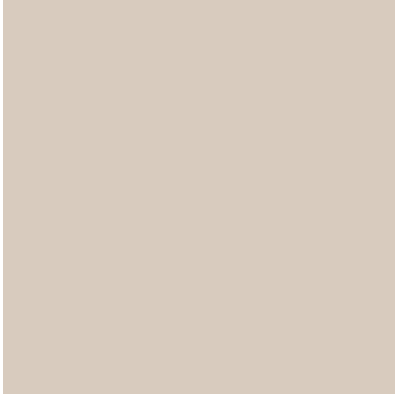

CASHMERE

NEW!



HAMILTON OAK VERTICAL

NEW!

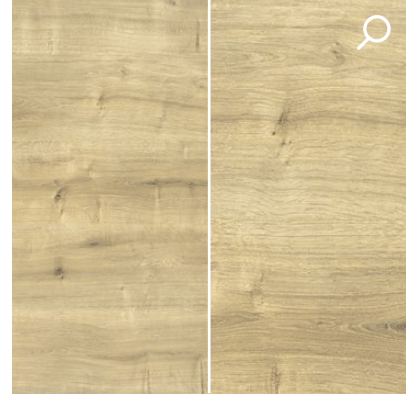

HAMILTON OAK HORIZONTAL

NEW!

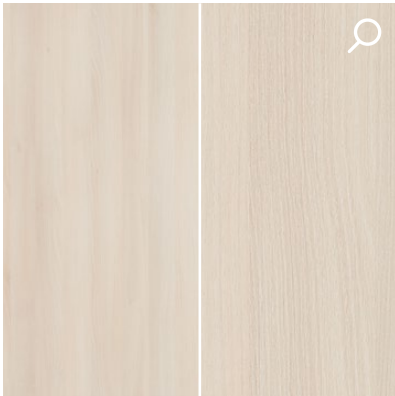

LIGHT ACACIA

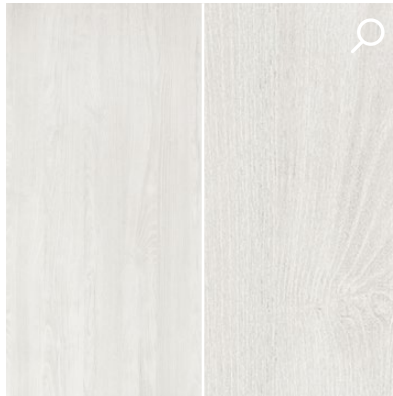

NORWEGIAN ASH

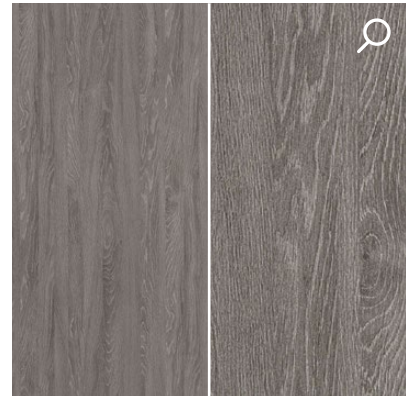

GRIGIO OAK

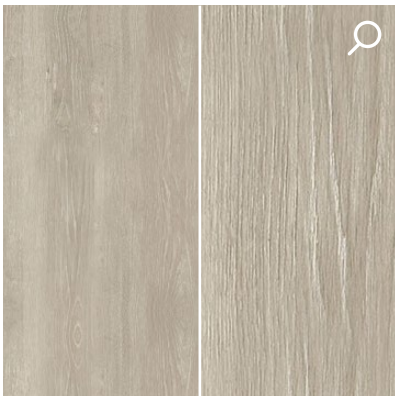

KENDAL OAK

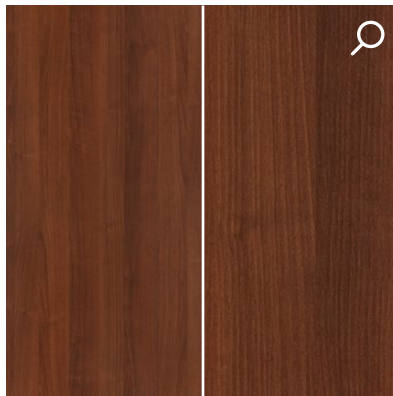

ITALIAN WALNUT

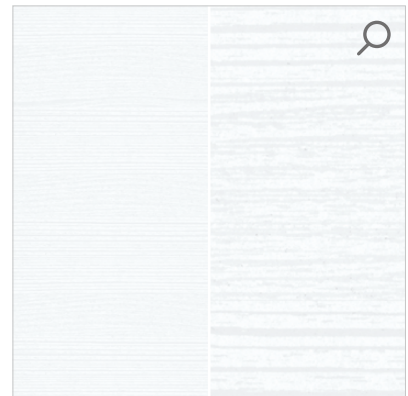

WHITE WITH HORIZONTAL STRUCTURE



GRAPHITE RAL 7024

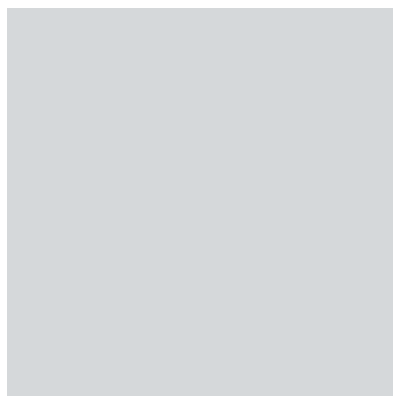

GRAY RAL 7047

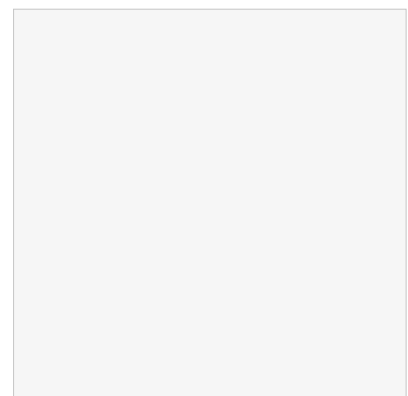

WHITE RAL 9003

VENEER / LACQUER

HPL

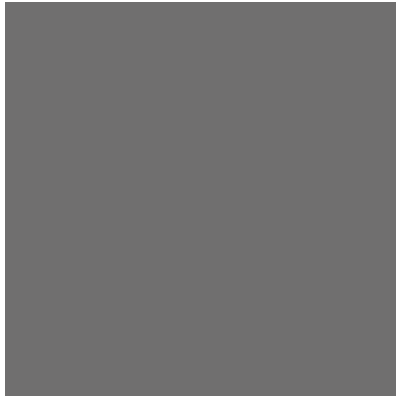

GRAPHITE RAL 7024



GRAY RAL 7047

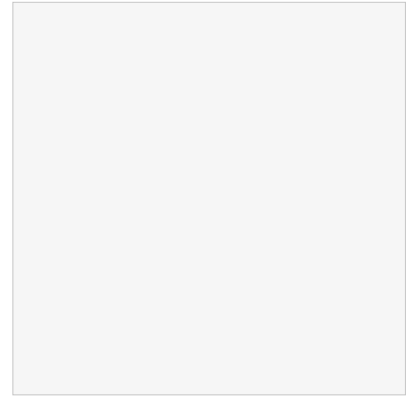

WHITE RAL 9003

LACQUER

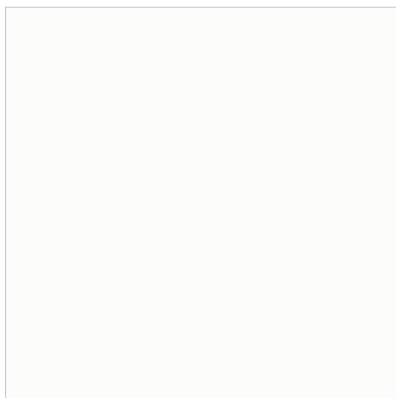

WHITE – LACQUERED, SIMILAR TO RAL 9003

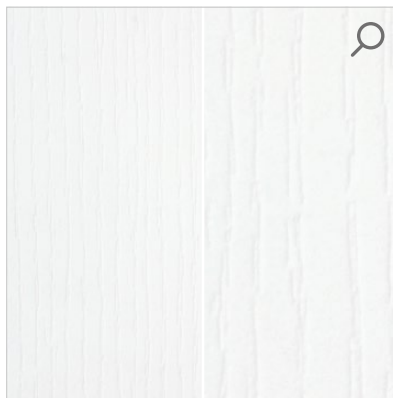

WHITE – LACQUERED WITH STRUCTURE



GRAY – LACQUERED, SIMILAR TO RAL 7004

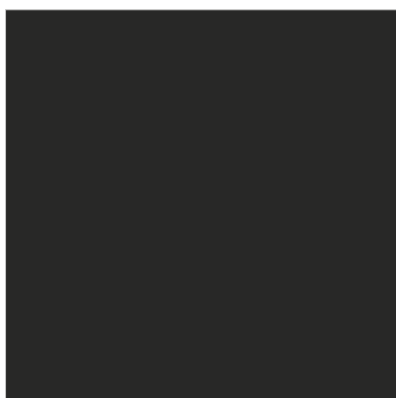

BLACK – LACQUERED, SIMILAR TO RAL 9005

A top-down view of a person's hands using a tablet to view a digital color palette. The tablet screen displays a grid of color swatches. The person is wearing a grey wristband. The desk is cluttered with various color swatches, including a large fan of color swatches at the top, several smaller printed color charts, and several yellow and pink sticky notes. A laptop keyboard is visible in the bottom left corner. The background is a light-colored wooden desk.

CHOOSE COLOR
WHICH SUITS
YOU BEST

HPL UNI DECORS

Available upon individual enquiries. Details in the Customer Service department.

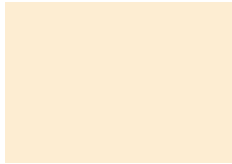

Cotton
U113 – NCS S0907-Y30R



Vibrant Yellow
U114 – NCS S1060-Y10R



Citrus Yellow
U131 – NCS S0560-G90Y



Sand Beige
U156 – NCS S1505-Y50R



Curry Yellow
U163 – NCS S2060-Y10R



Silicon Gray
U201 – NCS S3502-Y

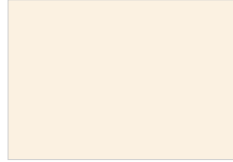

Came Beige
U216 – NCS S0502-Y50R



Burgundy
U311 – NCS S5040-R



Chinese Red
U321 – NCS S1580-Y90R



Chili Red
U323 – NCS S3060-R

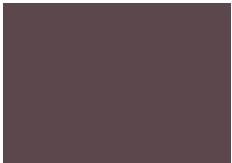

Aubergine
U330 – NCS S7010-R30B

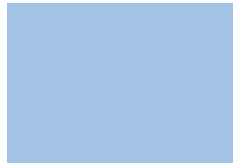

Blue Horizon
U522 – NCS S1030-R80B



Faience Blue
U525 – NCS S3060-R90B



Indigo Blue
U599 – NCS S8505-R80B



Kiwi green
U626 – NCS S3050-G40Y



Lime Green
U630 – NCS S1060-G40Y



Niagara Green
U646 – NCS S5030-B30G

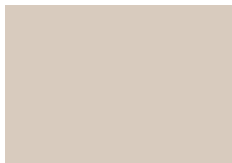

Cashmere
U702 – NCS S2005-Y60R

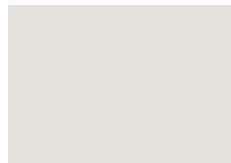

Silky Gray
U707 – NCS S1500-N

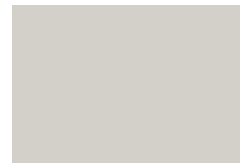

Light Gray
U708 – NCS S2000-N



Stone Gray
U727 – NCS S4005-Y50R



Dust Gray
U732 – NCS S5000-N



Lava Gray
U741 – NCS S7005-Y20R



Taupe Gray
U750 – NCS S2005-Y20R



Pearl Gray
U763 – NCS S2500-N

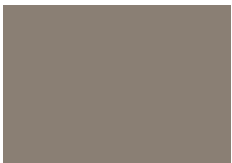

Cubanite Gray
U767 – NCS S6005-Y20R

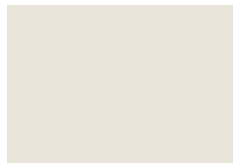

White Gray
U775 – NCS S1000-N



Artic Gray
U788 – NCS S4500-N



Velvet Black
U899 – NCS S8500-N



Gray Onyx
U960 – NCS S6500-N



Graphite Gray
U961 – NCS S8000-N



Diamond Gray
U963 – NCS S7500-N



Black
U999 – NCS S9000-N

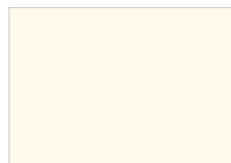

White
W911 – NCS S0502-G50Y

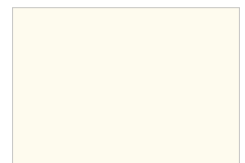

Platinum White
W980 – NCS S0300-N

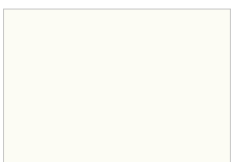

Premium White ST22
W1000 – NCS S0500-N

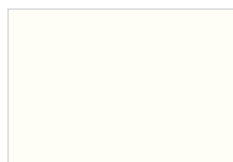

Premium White solid
W1001 – NCS S0500-N

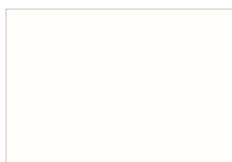

Alpine White
W1100 – NCS S0502-R50B

HPL WOOD DECORS

Available upon individual enquiries. Details in the Customer Service department.



Dark Gray Chicago Concrete
F187



Light Concrete
F274



Metallic Inox
F500



Aluminium
F509



Black-Gold Metal Slate
F629



Gray-Beige Bamenda
H1115



Natural Bardolino Oak
H1145



Gray Arizona Oak
H1150



Navarra Ash
H1250



Natural Branson Robinia
H1251

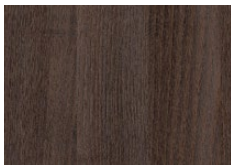

Truffle Branson Robinia
H1253

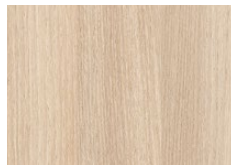

Light Lakeland Acacia
H1277

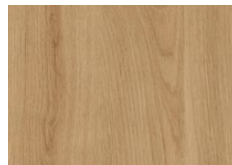

Natural Wild Oak
H1318

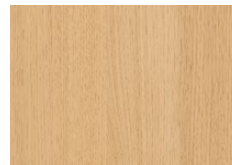

Light Sorano Oak
H1334

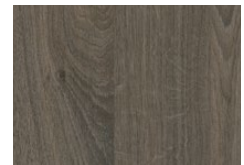

Graphite Denver Oak
H1387



Ellmau Beech
H1582

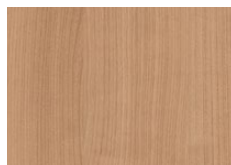

Verona Cherry
H1615

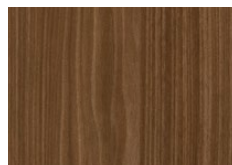

Lincoln Walnut
H1714

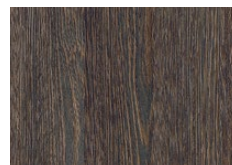

Mali Wenge
H3058

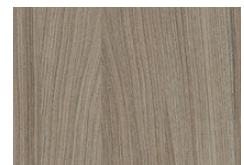

Shorewood
H3090

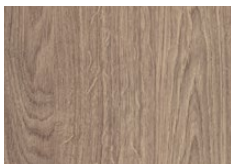

Gray Corbridge Oak
H3156

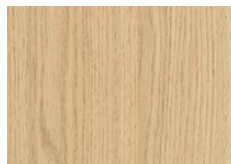

Vicenza Oak
H3157

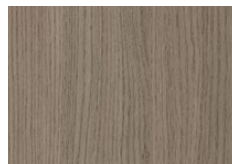

Gray Vicenza Oak
H3158

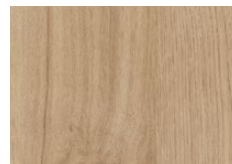

Natural Kendal Oak
H3170

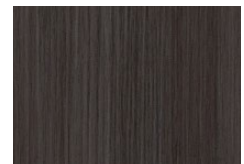

Anthracite Finesline Metallic
H3190

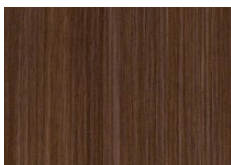

Brown Finesline Metallic
H3192

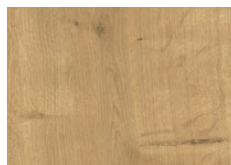

Natural Hamilton Oak
H3303



Gray Nebraska Oak
H3332

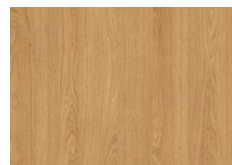

Natural Cordbridge Oak
H3395

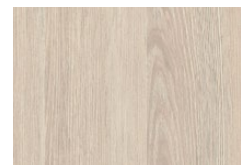

White Aland Pine
H3430



Polar Aland Pine
H3433

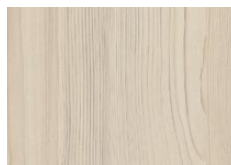

White Fleetwood
H3450

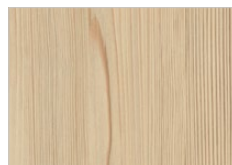

Champagne Fleetwood
H3451

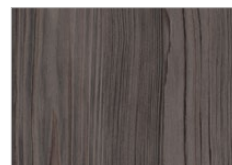

Gray Lava Fleetwood
H3453

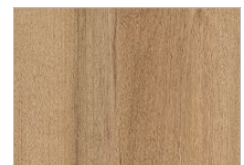

Natural Pacific Walnut
H3700

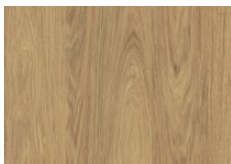

Natural Hickory
H3730

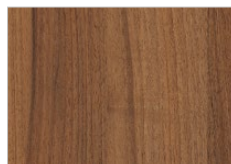

Natural Dijon Walnut
H3734

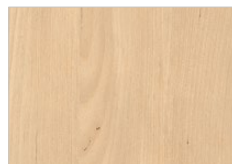

Natural Mandal Maple
H3840

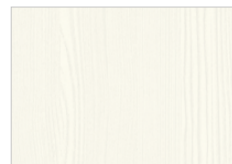

Premium White ST19
W1000_ST19



Classen-Pol S.A.

ul. Wyzwolenia,
44-292 Zwonowice k. Rybnika
phone: +48 (32) 429 20 00

e-mail: biuro@classen.com.pl

www.classen.pl

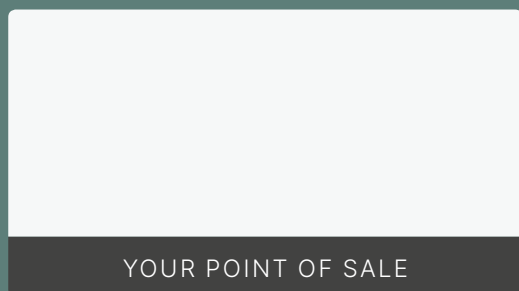

The catalogue does not constitute an offer within the meaning of commercial law. Classen-Pol S.A. reserves the right to change and improve the products presented in this publication without prior notice. Information contained in this catalogue is correct at the time of publishing.

Colours presented in this catalogue may differ from the products that are on sale.



Art. no. 60010455 | CLASS. 04.2023/EN

